

www.bellowss.com

Advanced Welded Bellows & Vacuum total solution

GST CO.,LTD

www.bellowss.com

www.bellowss.com

Total Vacuum System

- CF FLANGES & FITTINGS
- KF FLANGES & DN FLANGES FITTINGS
- ISO FLANGES & FITTINGS
- ADAPTORS
- WELD FITTINGS
- BELLOWS, FLEXIBLE HOSES



88
()
Tel 031 321 7988 Fax 031 532 7998

Head Office

88, Bamdi-gil, Iwol-myeon, Jincheon-gun,
Chungcheongbuk-do, 27816, Republic of Korea
Tel +82 31 321 7988 Fax +82 43 532 7998

5 21-11()
1 607
Tel 031 321 7988 Fax 031 532 7998

Sales Office

#607, 21-11, Dongbaek 5-ro, Giheung-gu, Yongin-si,
Gyeonggi-do, 17006, Republic of Korea
Tel +82 31 321 7988 Fax +82 31 693 7951





CF FLANGES & FITTINGS

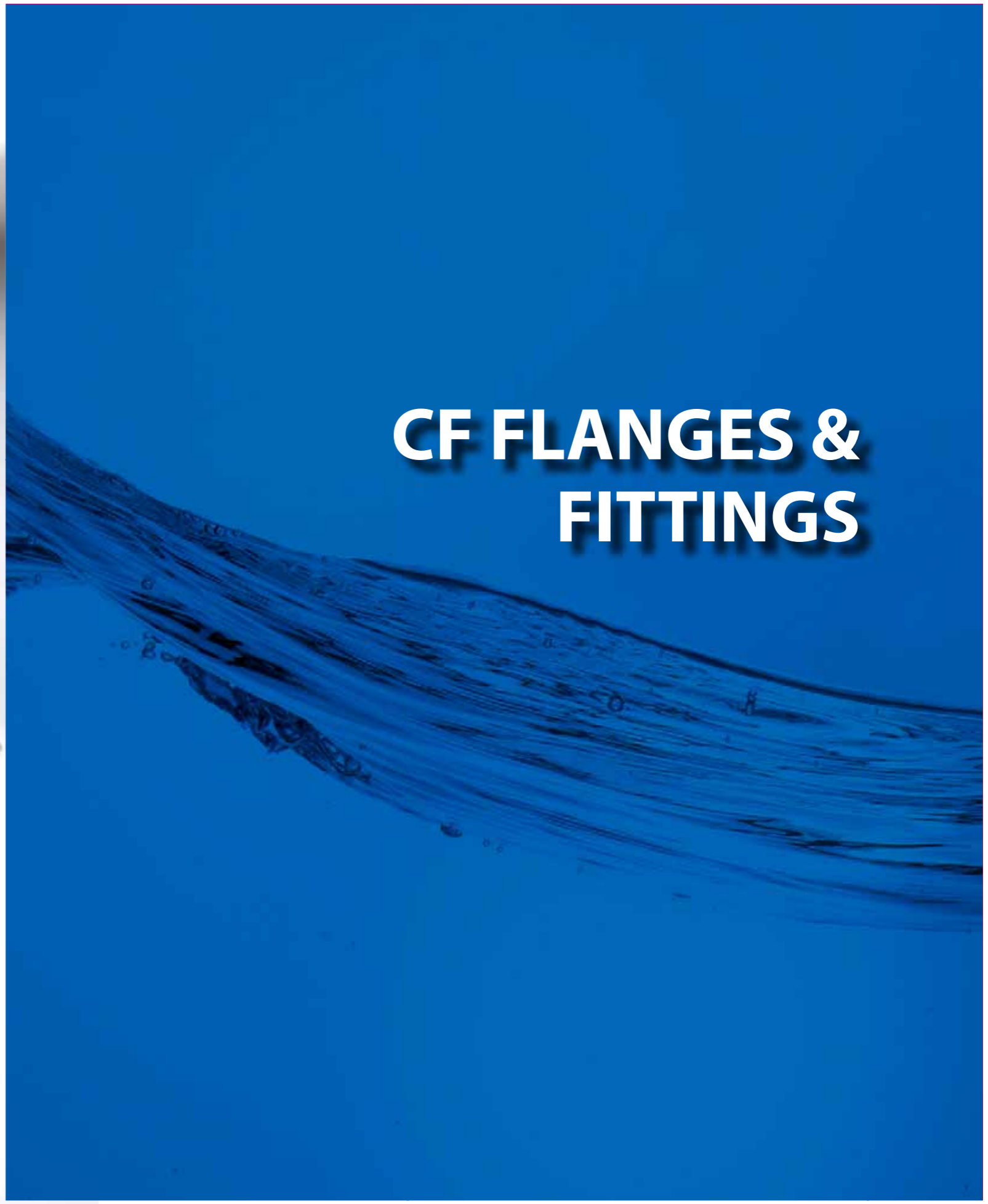

CF FLANGES & FITTINGS

Cleaning and Packaging

Products with weld joints are 100 percent helium leak tested to assure leak free. To ensure the cleanliness of GST products ready for onsite use, all part are ultrasonically cleaned with de- ionized water, and packaged in class 10,000 clean room environment. Each bag is affixed with a barcode label identifying the component's part number, heat number and batch number for full traceability.

STANDARD SPECIFICATION

Vacuum Rate:
Ultra High Vacuum

Materials:
304

Flange Sizes:
CF 1.33"~ CF 16.5"

Tube Sizes:
1/ 2"~6.0"

Vacuum Range:
760 Torr ~ 1 x 10 Torr for 304

Gasket Materials:
OFHC Copper or Silver Plated

Temperature Range:
-190°C ~ +450°C

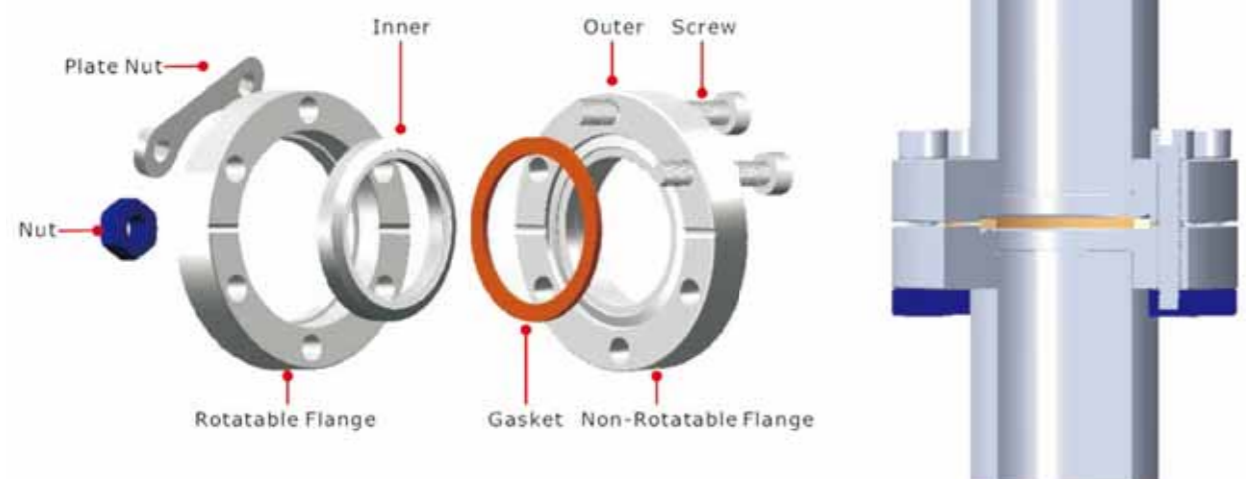

Rotatable CF flange – While components of several systems are used interchangeably, rotatable flanges are recommended to use.

Non-Rotatable CF Flanges – are less expensive due to containing both sealing surface and bolt holes in one unit. When mating component orientation is not concerned. Double face CF flange are also available upon request.

CF FLANGES & FITTINGS

OFHC COPPER SEALS

Catalogue PN	Flange Size	A	B
CF-CS-133	CF1.33"/CF16	16.20	21.25
CF-CS-212	CF2.12"/CF25	25.65	32.77
CF-CS-275	CF2.75"/CF35	36.80	48.10
CF-CS-275-1	CF2.75"/CF40	39.00	48.10
CF-CS-338	CF3.38"/CF50	51.05	61.60
CF-CS-450	CF4.50"/CF63	63.60	82.35
CF-CS-462	CF4.62"/CF80	76.45	91.39
CF-CS-600	CF6.00"/CF100	101.80	120.45
CF-CS-675	CF6.75"/CF130	127.25	141.40
CF-CS-800	CF8.00"/CF160	152.60	171.25
CF-CS-1000	CF10.00"/CF200	203.40	222.05
CF-CS-1200	CF12.00"/CF250	254.20	272.85
CF-CS-1325	CF13.25"/CF270	274.00	294.34
CF-CS-1400	CF14.00"/CF300	300.00	313.00
CF-CS-1650	CF16.50"/CF350	356.50	376.60

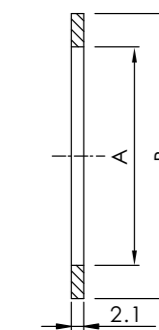

OFHC COPPER SEALS

Catalogue PN	Flange Size	A	B
CF-CS-133-S	CF1.33"/CF16	16.20	21.25
CF-CS-212-S	CF2.12"/CF25	25.65	32.77
CF-CS-275-S	CF2.75"/CF35	36.80	48.10
CF-CS-275-1-S	CF2.75"/CF40	39.00	48.10
CF-CS-338-S	CF3.38"/CF50	51.05	61.60
CF-CS-450-S	CF4.50"/CF63	63.60	82.35
CF-CS-462-S	CF4.62"/CF80	76.45	91.39
CF-CS-600-S	CF6.00"/CF100	101.80	120.45
CF-CS-675-S	CF6.75"/CF130	127.25	141.40
CF-CS-800-S	CF8.00"/CF160	152.60	171.25
CF-CS-1000-S	CF10.00"/CF200	203.40	222.05
CF-CS-1200-S	CF12.00"/CF250	254.20	272.85
CF-CS-1325-S	CF13.25"/CF270	274.00	294.34
CF-CS-1400-S	CF14.00"/CF300	300.00	313.00
CF-CS-1650-S	CF16.50"/CF350	356.50	376.60

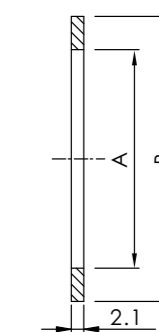

CF FLANGES & FITTINGS

CF FLANGE PLASTIC CAP

*MATERIAL: PE

Catalogue PN	Size	A	B
CF-PC-133	CF1.33"	36.20	34.20
CF-PC-212	CF2.12"	56.40	54.00
CF-PC-275	CF2.75"	72.10	70.10
CF-PC-338	CF3.38"	88.50	85.90
CF-PC-450	CF4.50"	118.30	113.50
CF-PC-462	CF4.62"	120.50	117.60
CF-PC-600	CF6.00"	156.40	151.60
CF-PC-675	CF6.75"	173.80	171.60
CF-PC-800	CF8.00"	206.00	202.00
CF-PC-1000	CF10.0"	258.00	254.00
CF-PC-1200	CF12.0"	309.00	304.60
CF-PC-1325	CF13.25"	341.10	336.70
CF-PC-1400	CF14.0"	360.10	355.70

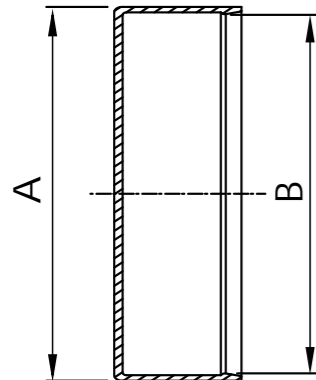

CF FLANGES & FITTINGS

CF BLANKER

*MATERIAL: 304
*TAPPED AND THROUGH HOLES

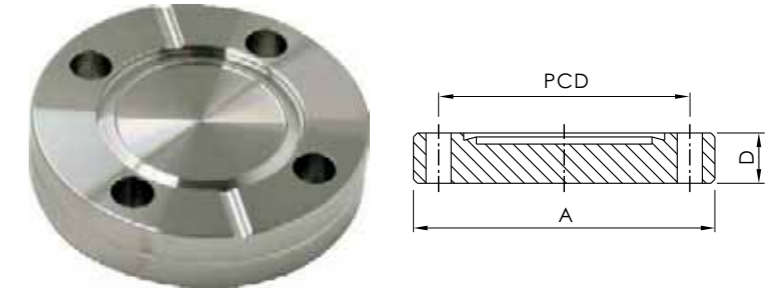

Catalogue PN	Type	Flange Size	A(mm)	D(mm)	PCD(mm)	Bolt Holes	Diameter / Thread(mm)
CF-BL-133	Thru Holes	CF1.33"/CF16	33.70	7.60	26.97	6	4.37
CF-BL-133T	Tapped	CF1.33"/CF16	33.70	7.60	26.97	6	8-32
CF-BL-133TM	Tapped(M)	CF1.33"/CF16	33.70	7.60	26.97	6	M4
CF-BL-212	Thru Holes	CF2.12"/CF25	53.80	11.90	41.28	4	6.73
CF-BL-212T	Tapped	CF2.12"/CF25	53.80	11.90	41.28	4	1/4-28
CF-BL-212TM	Tapped(M)	CF2.12"/CF25	53.80	11.90	41.28	4	M6
CF-BL-275	Thru Holes	CF2.75"/CF35	69.30	12.70	58.72	6	6.73
CF-BL-275T	Tapped	CF2.75"/CF35	69.30	12.70	58.72	6	1/4-28
CF-BL-275TM	Tapped(M)	CF2.75"/CF35	69.30	12.70	58.72	6	M6
CF-BL-338	Thru Holes	CF3.38"/CF50	85.30	16.00	72.39	8	8.43
CF-BL-338T	Tapped	CF3.38"/CF50	85.30	16.00	72.39	8	5/16-24
CF-BL-338TM	Tapped(M)	CF3.38"/CF50	85.30	16.00	72.39	8	M8
CF-BL-450	Thru Holes	CF4.50"/CF63	113.50	17.30	92.15	8	8.43
CF-BL-450T	Tapped	CF4.50"/CF63	113.50	17.30	92.15	8	5/16-24
CF-BL-450TM	Tapped(M)	CF4.50"/CF63	113.50	17.30	92.15	8	M8
CF-BL-462	Thru Holes	CF4.62"/CF80	117.00	19.10	102.36	10	8.43
CF-BL-462T	Tapped	CF4.62"/CF80	117.00	19.10	102.36	10	5/16-24
CF-BL-462TM	Tapped(M)	CF4.62"/CF80	117.00	19.10	102.36	10	M8
CF-BL-600	Thru Holes	CF6.00"/CF100	151.60	19.80	130.25	16	8.43
CF-BL-600T	Tapped	CF6.00"/CF100	151.60	19.80	130.25	16	5/16-24
CF-BL-600TM	Tapped(M)	CF6.00"/CF100	151.60	19.80	130.25	16	M8
CF-BL-675	Thru Holes	CF6.75"/CF130	170.69	21.30	151.61	18	8.43
CF-BL-T	Tapped	CF6.75"/CF130	170.69	21.30	151.61	18	5/16-24
CF-BL-TM	Tapped(M)	CF6.75"/CF130	170.69	21.30	151.61	18	M8
CF-BL-800	Thru Holes	CF8.00"/CF160	202.44	22.35	181.05	20	8.43
CF-BL-800T	Tapped	CF8.00"/CF160	202.44	22.35	181.05	20	5/16-24
CF-BL-800TM	Tapped(M)	CF8.00"/CF160	202.44	22.35	181.05	20	M8
CF-BL-1000	Thru Holes	CF10.00"/CF200	253.24	24.60	231.85	24	8.43
CF-BL-1000T	Tapped	CF10.00"/CF200	253.24	24.60	231.85	24	5/16-24
CF-BL-1000TM	Tapped(M)	CF10.00"/CF200	253.24	24.60	231.85	24	M8
CF-BL-1200	Thru Holes	CF12.00"/CF250	304.40	25.90	283.97	32	8.43
CF-BL-1200T	Tapped	CF12.00"/CF250	304.40	25.90	283.97	32	5/16-24
CF-BL-1200TM	Tapped(M)	CF12.00"/CF250	304.40	25.90	283.97	32	M8
CF-BL-1325	Thru Holes	CF13.25"/CF270	335.79	28.45	306.32	30	10.49
CF-BL-1325T	Tapped	CF13.25"/CF270	335.79	28.45	306.32	30	3/8-24
CF-BL-1325TM	Tapped(M)	CF13.25"/CF270	335.79	28.45	306.32	30	M10
CF-BL-1400	Thru Holes	CF14.00"/CF300	354.84	28.45	325.37	30	10.49
CF-BL-1400T	Tapped	CF14.00"/CF300	354.84	28.45	325.37	30	3/8-24
CF-BL-1400TM	Tapped(M)	CF14.00"/CF300	354.84	28.45	325.37	30	M10
CF-BL-1650	Thru Holes	CF16.50"/CF350	418.34	28.45	388.87	36	10.49
CF-BL-1650T	Tapped	CF16.50"/CF350	418.34	28.45	388.87	36	3/8-24
CF-BL-1650TM	Tapped(M)	CF16.50"/CF350	418.34	28.45	388.87	36	M10

*NOTE: 316L MATERIAL AVAILABLE ON REQUEST.

CF FLANGES & FITTINGS

CF BLANKER, ROTATABLE

*MATERIAL: 304
*TAPPED AND THROUGH HOLES

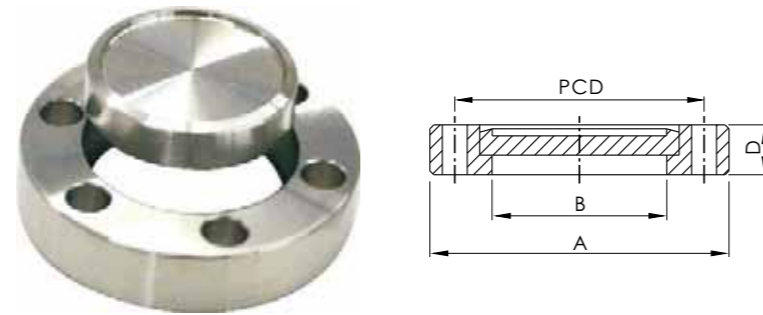

Catalogue PN	Type	Flange Size	A(mm)	D(mm)	PCD(mm)	Bolt Holes	Diameter / Thread(mm)
CF-BL-133R	Thru Holes	CF 1.33 "/CF 16	33.70	19.41	7.60	6	4.37
CF-BL-133RT	Tapped	CF 1.33 "/CF 16	33.70	19.41	7.60	6	8-32
CF-BL-133RTM	Tapped(M)	CF 1.33 "/CF 16	33.70	19.41	7.60	6	M4
CF-BL-212R	Thru Holes	CF 2.12 "/CF 25	53.80	27.94	11.90	4	6.73
CF-BL-212RT	Tapped	CF 2.12 "/CF 25	53.80	27.94	11.90	4	1/4-28
CF-BL-212RTM	Tapped(M)	CF 2.12 "/CF 25	53.80	27.94	11.90	4	M6
CF-BL-275R	Thru Holes	CF 2.75 "/CF 35	69.30	48.31	12.70	6	6.73
CF-BL-275RT	Tapped	CF 2.75 "/CF 35	69.30	48.31	12.70	6	1/4-28
CF-BL-275RTM	Tapped(M)	CF 2.75 "/CF 35	69.30	48.31	12.70	6	M6
CF-BL-338R	Thru Holes	CF 3.38 "/CF 50	85.30	54.50	17.40	8	8.43
CF-BL-338RT	Tapped	CF 3.38 "/CF 50	85.30	54.50	17.40	8	5/16-24
CF-BL-338RTM	Tapped(M)	CF 3.38 "/CF 50	85.30	54.50	17.40	8	M8
CF-BL-450R	Thru Holes	CF 4.50 "/CF 63	113.50	72.39	19.10	8	8.43
CF-BL-450RT	Tapped	CF 4.50 "/CF 63	113.50	72.39	19.10	8	5/16-24
CF-BL-450RTM	Tapped(M)	CF 4.50 "/CF 63	113.50	72.39	19.10	8	M8
CF-BL-462R	Thru Holes	CF 4.62 "/CF 80	117.00	79.71	20.60	10	8.43
CF-BL-462RT	Tapped	CF 4.62 "/CF 80	117.00	79.71	20.60	10	5/16-24
CF-BL-462RTM	Tapped(M)	CF 4.62 "/CF 80	117.00	79.71	20.60	10	M8
CF-BL-600R	Thru Holes	CF 6.00 "/CF 10 0	151.60	106.17	21.30	16	8.43
CF-BL-600RT	Tapped	CF 6.00 "/CF 10 0	151.60	106.17	21.30	16	5/16-24
CF-BL-600RTM	Tapped(M)	CF 6.00 "/CF 10 0	151.60	106.17	21.30	16	M8
CF-BL-675R	Thru Holes	CF 6.75 "/CF 13 0	170.69	129.50	21.30	18	8.43
CF-BL-675RT	Tapped	CF 6.75 "/CF 13 0	170.69	129.50	21.30	18	5/16-24
CF-BL-675RTM	Tapped(M)	CF 6.75 "/CF 13 0	170.69	129.50	21.30	18	M8
CF-BL-800R	Thru Holes	CF 8.00 "/CF 16 0	202.44	155.70	23.90	20	8.43
CF-BL-800RT	Tapped	CF 8.00 "/CF 16 0	202.44	155.70	23.90	20	5/16-24
CF-BL-800RTM	Tapped(M)	CF 8.00 "/CF 16 0	202.44	155.70	23.90	20	M8
CF-BL-1000R	Thru Holes	CF 10.00 "/CF 20 0	253.24	208.28	24.60	24	8.43
CF-BL-1000RT	Tapped	CF 10.00 "/CF 20 0	253.24	208.28	24.60	24	5/16-24
CF-BL-1000RTM	Tapped(M)	CF 10.00 "/CF 20 0	253.24	208.28	24.60	24	M8
CF-BL-1200R	Thru Holes	CF 12.00 "/CF 25 0	304.04	256.03	25.90	32	8.43
CF-BL-1200RT	Tapped	CF 12.00 "/CF 25 0	304.04	256.03	25.90	32	5/16-24
CF-BL-1200RTM	Tapped(M)	CF 12.00 "/CF 25 0	304.04	256.03	25.90	32	M8
CF-BL-1325R	Thru Holes	CF 13.25 "/CF 27 0	335.79	276.30	28.45	30	10.49
CF-BL-1325RT	Tapped	CF 13.25 "/CF 27 0	335.79	276.30	28.45	30	3/8-24
CF-BL-1325RTM	Tapped(M)	CF 13.25 "/CF 27 0	335.79	276.30	28.45	30	M10
CF-BL-1400R	Thru Holes	CF 14.00 "/CF 30 0	354.84	305.82	28.45	30	10.49
CF-BL-1400RT	Tapped	CF 14.00 "/CF 30 0	354.84	305.82	28.45	30	3/8-24
CF-BL-1400RTM	Tapped(M)	CF 14.00 "/CF 30 0	354.84	305.82	28.45	30	M10
CF-BL-1650R	Thru Holes	CF 16.50 "/CF 35 0	418.34	359.61	28.45	36	10.49
CF-BL1650RT	Tapped	CF 16.50 "/CF 35 0	418.34	359.61	28.45	36	3/8-24
CF-BL1650RTM	Tapped(M)	CF 16.50 "/CF 35 0	418.34	359.61	28.45	36	M10

*NOTE: 316L MATERIAL AVAILABLE ON REQUEST.

CF FLANGES & FITTINGS

CF DOUBLE FACE FLANGES

*MATERIAL: 304
*THRU BOLT HOLES

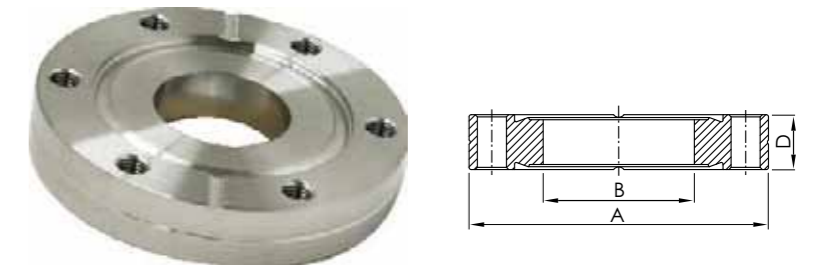

Catalogue PN	Type	Flange Size	A(mm)	D(mm)	PCD(mm)	Bolt Holes	Diameter / Thread(mm)
CF-DF-133	Blank	CF1.33"	33.70	-	7.60	6	4.37
CF-DF-133x075	Bored	CF1.33" - 3/4"	33.70	15.88	7.60	6	4.37
CF-DF-212	Blank	CF2.12"	53.80	-	11.90	4	6.73
CF-DF-212x100	Bored	CF2.12" - 1.0"	53.80	25.65	11.90	4	6.73
CF-DF-275	Blank	CF2.75"	69.30	-	12.70	6	6.73
CF-DF-275x150	Bored	CF2.75" - 1.5"	69.30	38.35	12.70	6	6.73
CF-DF-338	Blank	CF3.38"	85.30	-	16.00	8	8.43
CF-DF-338x200	Bored	CF3.38" - 2.0"	85.30	51.05	16.00	8	8.43
CF-DF-450	Blank	CF4.50"	113.50	-	17.40	8	8.43
CF-DF-450x250	Bored	CF4.50" - 2.5"	113.50	63.75	17.40	8	8.43
CF-DF-462	Blank	CF4.62"	117.00	-	19.10	10	8.43
CF-DF-462x300	Bored	CF4.62" - 3.0"	117.00	79.71	19.10	10	8.43
CF-DF-600	Blank	CF6.00"	151.60	-	19.80	16	8.43
CF-DF-600x400	Bored	CF6.00" - 4.0"	151.60	101.85	19.80	16	8.43
CF-DF-675	Blank	CF6.75"	170.69	-	21.34	18	8.43
CF-DF-675x500	Bored	CF6.75" - 5.0"	170.69	127.25	21.34	18	8.43
CF-DF-800	Blank	CF8.00"	202.44	-	22.35	20	8.43
CF-DF-800x600	Bored	CF8.00" - 6.0"	202.44	152.65	22.35	20	8.43
CF-DF-1000	Blank	CF10.0"	253.24	-	24.60	24	8.43
CF-DF-1000x800	Bored	CF10.0" - 8.0"	253.24	203.45	24.60	24	8.43
CF-DF-1325	Blank	CF13.25"	335.79	-	28.45	30	10.49
CF-DF-1325x1000	Bored	CF13.25" - 10"	335.79	254.50	28.45	30	10.49

*NOTE: 316L MATERIAL AVAILABLE ON REQUEST.

CF FLANGES & FITTINGS

CF ZERO LENGTH REDUCERS

*MATERIAL: 304

*NOTE: 316LN MATERIAL AVAILABLE ON REQUEST.

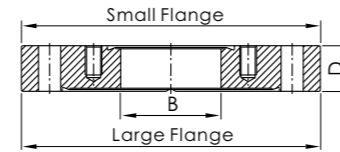

Catalogue PN	Large Flange	Small Flange	Tube Size	B(mm)	C(mm)
CF-ZL-275x133z	CF2.75" Thru holes	CF1.33" Tapped holes	3/4"	15.75	12.70
CF-ZL-338x133z	CF3.38" Thru holes	CF1.33" Tapped holes	3/4"	15.75	16.00
CF-ZL-338x212z	CF3.38" Thru holes	CF2.12" Tapped holes	1.0"	25.40	16.00
CF-ZL-450x133z	CF4.50" Thru holes	CF1.33" Tapped holes	3/4"	15.75	17.40
CF-ZL-450x212z	CF4.50" Thru holes	CF2.12" Tapped holes	1.0"	25.40	17.40
CF-ZL-450x275z	CF4.50" Thru holes	CF2.75" Tapped holes	1.5"	38.10	17.40
CF-ZL-462x133z	CF4.62" Thru holes	CF1.33" Tapped holes	3/4"	15.75	19.10
CF-ZL-462x212z	CF4.62" Thru holes	CF2.12" Tapped holes	1.0"	25.40	19.10
CF-ZL-462x275z	CF4.62" Thru holes	CF2.75" Tapped holes	1.5"	38.10	19.10
CF-ZL-462x338z	CF4.62" Thru holes	CF3.38" Tapped holes	2.0"	50.80	19.10
CF-ZL-600x133z	CF6.00" Thru holes	CF1.33" Tapped holes	3/4"	15.75	19.80
CF-ZL-600x212z	CF6.00" Thru holes	CF2.12" Tapped holes	1.0"	25.40	19.80
CF-ZL-600x275z	CF6.00" Thru holes	CF2.75" Tapped holes	1.5"	38.10	19.80
CF-ZL-600x338z	CF6.00" Thru holes	CF3.38" Tapped holes	2.0"	50.80	19.80
CF-ZL-600x450z	CF6.00" Thru holes	CF4.50" Tapped holes	2.5"	63.50	19.80
CF-ZL-675x275z	CF6.75" Thru holes	CF2.75" Tapped holes	1.5"	38.10	21.34
CF-ZL-675x450z	CF6.75" Thru holes	CF4.50" Tapped holes	2.5"	63.50	21.34
CF-ZL-800x133z	CF8.00" Thru holes	CF1.33" Tapped holes	3/4"	15.75	22.35
CF-ZL-800x275z	CF8.00" Thru holes	CF2.75" Tapped holes	1.5"	38.10	22.35
CF-ZL-800x450z	CF8.00" Thru holes	CF4.50" Tapped holes	2.5"	63.50	22.35
CF-ZL-800x600z	CF8.00" Thru holes	CF6.00" Tapped holes	4.0"	101.60	22.35
CF-ZL-1000x133z	CF10.00" Thru holes	CF1.33" Tapped holes	3/4"	15.75	24.60
CF-ZL-1000x275z	CF10.00" Thru holes	CF2.75" Tapped holes	1.5"	38.10	24.60
CF-ZL-1000x450z	CF10.00" Thru holes	CF4.50" Tapped holes	2.5"	63.50	24.60
CF-ZL-1000x600z	CF10.00" Thru holes	CF6.00" Tapped holes	4.0"	101.60	24.60
CF-ZL-1000x800z	CF10.00" Thru holes	CF8.00" Tapped holes	6.0"	152.40	24.60
CF-ZL-1325x133z	CF13.25" Thru holes	CF1.33" Tapped holes	3/4"	15.75	28.45
CF-ZL-1325x275z	CF13.25" Thru holes	CF2.75" Tapped holes	1.5"	38.10	28.45
CF-ZL-1325x450z	CF13.25" Thru holes	CF4.50" Tapped holes	2.5"	63.50	28.45
CF-ZL-1325x600z	CF13.25" Thru holes	CF6.00" Tapped holes	4.0"	101.60	28.45
CF-ZL-1325x800z	CF13.25" Thru holes	CF8.00" Tapped holes	6.0"	152.40	28.45
CF-ZL-1325x1000z	CF13.25" Thru holes	CF10.00" Tapped holes	8.0"	203.20	28.45

CF FLANGES & FITTINGS

CF BORED FLANGES

*MATERIAL: 304

* TAPPED AND THROUGH HOLES

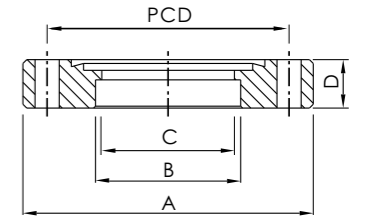

Catalogue PN	Type	Flange-Tube	A(mm)	B(mm)	C(mm)	D(mm)	PCD(mm)	Bolt Holes	Diameter / Thread(mm)
CF-BF-133x038	Thru Holes	CF1.33"-0.38"	33.70	9.65	-	7.60	26.97	6	4.37
CF-BF-133x038T	Tapped	CF1.33"-0.38"	33.70	9.65	-	7.60	26.97	6	8-32
CF-BF-133x038TM	Tapped(M)	CF1.33"-0.38"	33.70	9.65	-	7.60	26.97	6	M4
CF-BF-133x050	Thru Holes	CF1.33"-0.50"	33.70	12.83	-	7.60	26.97	6	4.37
CF-BF-133x050T	Tapped	CF1.33"-0.50"	33.70	12.83	-	7.60	26.97	6	8-32
CF-BF-133x050TM	Tapped(M)	CF1.33"-0.50"	33.70	12.83	-	7.60	26.97	6	M4
CF-BF-133x075	Thru Holes	CF1.33"-0.75"	33.70	19.30	16.00	7.60	26.97	6	4.37
CF-BF-133x075T	Tapped	CF1.33"-0.75"	33.70	19.30	16.00	7.60	26.97	6	8-32
CF-BF-133x075TM	Tapped(M)	CF1.33"-0.75"	33.70	19.30	16.00	7.60	26.97	6	M4
CF-BF-212x100	Thru Holes	CF2.12"-1.00"	53.80	25.65	23.90	11.90	41.28	4	6.73
CF-BF-212x100T	Tapped	CF2.12"-1.00"	53.80	25.65	23.90	11.90	41.28	4	1/4-28
CF-BF-212x100TM	Tapped(M)	CF2.12"-1.00"	53.80	25.65	23.90	11.90	41.28	4	M6
CF-BF-275x075	Thru Holes	CF2.75"-0.75"	69.30	19.30	16.00	12.70	58.72	6	6.73
CF-BF-275x075T	Tapped	CF2.75"-0.75"	69.30	19.30	16.00	12.70	58.72	6	1/4-28
CF-BF-275x075TM	Tapped(M)	CF2.75"-0.75"	69.30	19.30	16.00	12.70	58.72	6	M6
CF-BF-275x100	Thru Holes	CF2.75"-1.00"	69.30	25.65	22.10	12.70	58.72	6	6.73
CF-BF-275x100T	Tapped	CF2.75"-1.00"	69.30	25.65	22.10	12.70	58.72	6	1/4-28
CF-BF-275x100TM	Tapped(M)	CF2.75"-1.00"	69.30	25.65	22.10	12.70	58.72	6	M6
CF-BF-275x150	Thru Holes	CF2.75"-1.50"	69.30	38.35	36.60	12.70	58.72	6	6.73
CF-BF-275x150T	Tapped	CF2.75"-1.50"	69.30	38.35	36.60	12.70	58.72	6	1/4-28
CF-BF-275x150TM	Tapped(M)	CF2.75"-1.50"	69.30	38.35	36.60	12.70	58.72	6	M6
CF-BF-275x175	Thru Holes	CF2.75"-1.75"	69.30	44.70	41.20	12.70	58.72	6	6.73
CF-BF-275x175T	Tapped	CF2.75"-1.75"	69.30	44.70	41.20	12.70	58.72	6	1/4-28
CF-BF-275x175TM	Tapped(M)	CF2.75"-1.75"	69.30	44.70	41.20	12.70	58.72	6	M6
CF-BF-338x200	Thru Holes	CF3.38"-2.00"	85.30	51.05	49.30	17.40	72.39	8	8.43
CF-BF-338x200T	Tapped	CF3.38"-2.00"	85.30	51.05	49.30	17.40	72.39	8	5/16-24
CF-BF-338x200TM	Tapped(M)	CF3.38"-2.00"	85.30	51.05	49.30	17.40	72.39	8	M8
CF-BF-450x250	Thru Holes	CF4.50"-2.50"	113.50	63.75	62.00	17.40	92.15	8	8.43
CF-BF-450x250T	Tapped	CF4.50"-2.50"	113.50	63.75	62.00	17.40	92.15	8	5/16-24
CF-BF-450x250TM	Tapped(M)	CF4.50"-2.50"	113.50	63.75	62.00	17.40	92.15	8	M8
CF-BF-462x300	Thru Holes	CF4.62"-3.00"	117.00	76.45	74.70	20.60	102.36	10	8.43
CF-BF-462x300T	Tapped	CF4.62"-3.00"	117.00	76.45	74.70	20.60	102.36	10	5/16-24
CF-BF-462x300TM	Tapped(M)	CF4.62"-3.00"	117.00	76.45	74.70	20.60	102.36	10	M8
CF-BF-600x400	Thru Holes	CF6.00"-4.00"	151.60	101.85	99.60	19.80	130.25	16	8.43
CF-BF-600x400T	Tapped	CF6.00"-4.00"	151.60	101.85	99.60	19.80	130.25	16	5/16-24
CF-BF-600x400TM	Tapped(M)	CF6.00"-4.00"	151.60	101.85	99.60	19.80	130.25	16	M8
CF-BF-675x500	Thru Holes	CF6.75"-5.00"	170.69	127.25	123.83	21.34	151.61	18	8.43
CF-BF-675x500T	Tapped	CF6.75"-5.00"	170.69	127.25	123.83	21.34	151.61	18	5/16-24
CF-BF-675x500TM	Tapped(M)	CF6.75"-5.00"	170.69	127.25	123.83	21.34	151.61	18	M8
CF-BF-800x600	Thru Holes	CF8.00"-6.00"	202.44	152.91	150.40	22.35	181.05	20	8.43
CF-BF-800x600T	Tapped	CF8.00"-6.00"	202.44	152.91	150.40	22.35	181.05	20	5/16-24
CF-BF-800x600TM	Tapped(M)	CF8.00"-6.00"	202.44	152.91	150.40	22.35	181.05	20	M8
CF-BF-1000x800	Thru Holes	CF10.00"-8.00"	253.24	203.71	200.40	24.64	231.85	24	8.43
CF-BF-1000x800T	Tapped	CF10.00"-8.00"	253.24	203.71	200.40	24.64	231.85	24	5/16-24
CF-BF-1000x800TM	Tapped(M)	CF10.00"-8.00"	253.24	203.71	200.40	24.64	231.85	24	M8
CF-BF-1200x1000	Thru Holes	CF12.00"-10.00"	304.04	254.51	250.95	25.90	283.97	32	8.43
CF-BF-1200x1000T	Tapped	CF12.00"-10.00"	304.04	254.51	250.95	25.90	283.97	32	5/16-24
CF-BF-1200x1000TM	Tapped(M)	CF12.00"-10.00"	304.04	254.51	250.95	25.90	283.97	32	M8
CF-BF-1325x1000	Thru Holes	CF13.25"-10.00"	335.79	254.51	250.95	28.45	306.32	30	10.49
CF-BF-1325x1000T	Tapped	CF13.25"-10.00"	335.79	254.51	250.95	28.45	306.32	30	3/8-24
CF-BF-1325x1000TM	Tapped(M)	CF13.25"-10.00"	335.79	254.51	250.95	28.45	306.32	30	M10
CF-BF-1400x1200	Thru Holes	CF14.00"-12.00"	354.84	305.31	301.75	28.45	325.37	30	10.49
CF-BF-1400x1200T	Tapped	CF14.00"-12.00"	354.84	305.31	301.75	28.45	325.37	30	3/8-24
CF-BF-1400x1200TM	Tapped(M)	CF14.00"-12.00"	354.84	305.31	301.75	28.45	325.37	30	M10
CF-BF-1650x1400	Thru Holes	CF16.50"-14.00"	418.34	356.11	352.00	28.45	388.87	36	10.49
CF-BF-1650x1400T	Tapped	CF16.50"-14.00"	418.34	356.11	352.00	28.45	388.87	36	3/8-24
CF-BF-1650x1400TM	Tapped(M)	CF16.50"-14.00"	418.34	356.11	352.00	28.45	388.87	36	M10

*NOTE: 316L MATERIAL AVAILABLE ON REQUEST.

CF FLANGES & FITTINGS

CF BORED FLANGES, ROTATABLE

*MATERIAL: 304
* TAPPED AND THROUGH HOLES

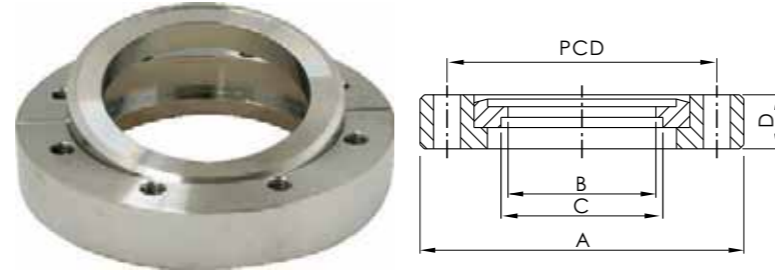

Catalogue PN	Type	Flange-Tube	A(mm)	B(mm)	C(mm)	D(mm)	PCD(mm)	Bolt Holes	Diameter / Thread(mm)
CF-BF-133x050R	Thru Holes	CF1.33"-0.50"	33.70	12.83	12.83	7.60	26.97	6	4.37
CF-BF-133x050RT	Tapped	CF1.33"-0.50"	33.70	12.83	12.83	7.60	26.97	6	8-32
CF-BF-133x050RTM	Tapped(M)	CF1.33"-0.50"	33.70	12.83	12.83	7.60	26.97	10	M4
CF-BF-133x075R	Thru Holes	CF1.33"-0.75"	33.70	16.00	19.30	7.60	26.97	10	4.37
CF-BF-133x075RT	Tapped	CF1.33"-0.75"	33.70	16.00	19.30	7.60	26.97	10	8-32
CF-BF-133x075RTM	Tapped(M)	CF1.33"-0.75"	33.70	16.00	19.30	7.60	26.97	16	M4
CF-BF-212x100R	Thru Holes	CF2.12"-1.00"	53.80	23.90	25.91	11.90	41.28	16	6.73
CF-BF-212x100RT	Tapped	CF2.12"-1.00"	53.80	23.90	25.91	11.90	41.28	16	1/4-28
CF-BF-212x100RTM	Tapped(M)	CF2.12"-1.00"	53.80	23.90	25.91	11.90	41.28	18	M6
CF-BF-275x075R	Thru Holes	CF2.75"-0.75"	69.30	16.00	19.30	12.70	58.72	18	6.73
CF-BF-275x075RT	Tapped	CF2.75"-0.75"	69.30	16.00	19.30	12.70	58.72	18	1/4-28
CF-BF-275x075RTM	Tapped(M)	CF2.75"-0.75"	69.30	16.00	19.30	12.70	58.72	20	M6
CF-BF-275x150R	Thru Holes	CF2.75"-1.50"	69.30	36.60	38.61	12.70	58.72	20	6.73
CF-BF-275x150RT	Tapped	CF2.75"-1.50"	69.30	36.60	38.61	12.70	58.72	20	1/4-28
CF-BF-275x150RTM	Tapped(M)	CF2.75"-1.50"	69.30	36.60	38.61	12.70	58.72	24	M6
CF-BF-338x200R	Thru Holes	CF3.38"-2.00"	85.30	49.30	51.31	17.40	72.39	24	8.43
CF-BF-338x200RT	Tapped	CF3.38"-2.00"	85.30	49.30	51.31	17.40	72.39	24	5/16-24
CF-BF-338x200RTM	Tapped(M)	CF3.38"-2.00"	85.30	49.30	51.31	17.40	72.39	32	M8
CF-BF-450x250R	Thru Holes	CF4.50"-2.50"	113.50	62.00	64.01	19.10	92.15	32	8.43
CF-BF-450x250RT	Tapped	CF4.50"-2.50"	113.50	62.00	64.01	19.10	92.15	32	5/16-24
CF-BF-450x250RTM	Tapped(M)	CF4.50"-2.50"	113.50	62.00	64.01	19.10	92.15	30	M8
CF-BF-462x300R	Thru Holes	CF4.62"-3.00"	117.00	74.70	76.71	20.60	102.36	30	8.43
CF-BF-462x300RT	Tapped	CF4.62"-3.00"	117.00	74.70	76.71	20.60	102.36	30	5/16-24
CF-BF-462x300RTM	Tapped(M)	CF4.62"-3.00"	117.00	74.70	76.71	20.60	102.36	30	M8
CF-BF-600x400R	Thru Holes	CF6.00"-4.00"	151.60	99.60	102.11	21.30	130.25	30	8.43
CF-BF-600x400RT	Tapped	CF6.00"-4.00"	151.60	99.60	102.11	21.30	130.25	30	5/16-24
CF-BF-600x400RTM	Tapped(M)	CF6.00"-4.00"	151.60	99.60	102.11	21.30	130.25	36	M8
CF-BF-675x500R	Thru Holes	CF6.75"-5.00"	170.69	125.00	127.51	21.30	151.61	36	8.43
CF-BF-675x500RT	Tapped	CF6.75"-5.00"	170.69	125.00	127.51	21.30	151.61	36	5/16-24
CF-BF-675x500RTM	Tapped(M)	CF6.75"-5.00"	170.69	125.00	127.51	21.30	151.61	8	M8
CF-BF-800x600R	Thru Holes	CF8.00"-6.00"	202.44	150.40	152.91	23.90	181.05	10	8.43
CF-BF-800x600RT	Tapped	CF8.00"-6.00"	202.44	150.40	152.91	23.90	181.05	10	5/16-24
CF-BF-800x600RTM	Tapped(M)	CF8.00"-6.00"	202.44	150.40	152.91	23.90	181.05	10	M8
CF-BF-1000x800R	Thru Holes	CF10.00"-8.00"	253.24	200.40	203.71	24.60	231.85	16	8.43
CF-BF-1000x800RT	Tapped	CF10.00"-8.00"	253.24	200.40	203.71	24.60	231.85	16	5/16-24
CF-BF-1000x800RTM	Tapped(M)	CF10.00"-8.00"	253.24	200.40	203.71	24.60	231.85	16	M8
CF-BF-1200x1000R	Thru Holes	CF12.00"-10.00"	304.04	250.95	254.51	25.90	283.97	18	8.43
CF-BF-1200x1000RT	Tapped	CF12.00"-10.00"	304.04	250.95	254.51	25.90	283.97	18	5/16-24
CF-BF-1200x1000RTM	Tapped(M)	CF12.00"-10.00"	304.04	250.95	254.51	25.90	283.97	18	M8
CF-BF-1325x1000R	Thru Holes	CF13.25"-10.00"	335.79	250.95	254.51	28.45	306.32	20	10.49
CF-BF-1325x1000RT	Tapped	CF13.25"-10.00"	335.79	250.95	254.51	28.45	306.32	20	3/8-24
CF-BF-1325x1000RTM	Tapped(M)	CF13.25"-10.00"	335.79	250.95	254.51	28.45	306.32	20	M10
CF-BF-1400x1200R	Thru Holes	CF14.00"-12.00"	354.84	301.75	305.31	28.45	325.37	24	10.49
CF-BF-1400x1200RT	Tapped	CF14.00"-12.00"	354.84	301.75	305.31	28.45	325.37	24	3/8-24
CF-BF-1400x1200RTM	Tapped(M)	CF14.00"-12.00"	354.84	301.75	305.31	28.45	325.37	24	M10
CF-BF-1650x1400R	Thru Holes	CF16.50"-14.00"	418.34	352.55	356.11	28.45	388.87	32	10.49
CF-BF-1650x1400RT	Tapped	CF16.50"-14.00"	418.34	352.55	356.11	28.45	388.87	32	3/8-24
CF-BF-1650x1400RTM	Tapped(M)	CF16.50"-14.00"	418.34	352.55	356.11	28.45	388.87	32	M10
CF-BF-1325x1000	Thru Holes	CF13.25"-10.00"	335.79	254.51	250.95	28.45	306.32	30	10.49
CF-BF-1325x1000T	Tapped	CF13.25"-10.00"	335.79	254.51	250.95	28.45	306.32	30	3/8-24
CF-BF-1325x1000TM	Tapped(M)	CF13.25"-10.00"	335.79	254.51	250.95	28.45	306.32	30	M10
CF-BF-1400x1200	Thru Holes	CF14.00"-12.00"	354.84	305.31	301.75	28.45	325.37	30	10.49
CF-BF-1400x1200T	Tapped	CF14.00"-12.00"	354.84	305.31	301.75	28.45	325.37	30	3/8-24
CF-BF-1400x1200TM	Tapped(M)	CF14.00"-12.00"	354.84	305.31	301.75	28.45	325.37	30	M10
CF-BF-1650x1400	Thru Holes	CF16.50"-14.00"	418.34	356.11	352.00	28.45	388.87	36	10.49
CF-BF-1650x1400T	Tapped	CF16.50"-14.00"	418.34	356.11	352.00	28.45	388.87	36	3/8-24
CF-BF-1650x1400TM	Tapped(M)	CF16.50"-14.00"	418.34	356.11	352.00	28.45	388.87	36	M10

*NOTE: 316L MATERIAL AVAILABLE ON REQUEST.

CF FLANGES & FITTINGS

CF FLANGE HALF NIPPLES

*MATERIAL: 304 (FLANGES AND TUBES)

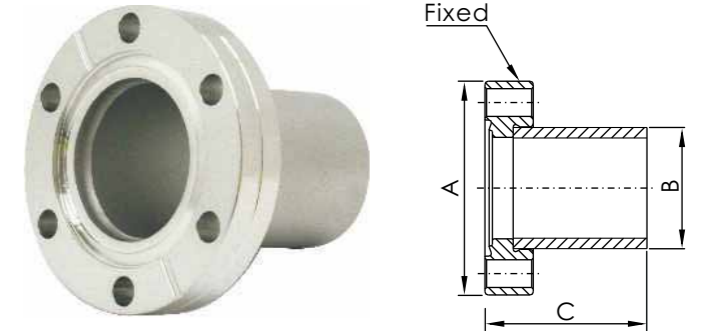

Catalogue PN	Flange Size	A	B	C
CF-HN-133	CF1.33"	1.33"	19.05	38.10
CF-HN-212	CF2.12"	2.12"	25.40	52.07
CF-HN-275	CF2.75"	2.75"	38.10	62.48
CF-HN-338	CF3.38"	3.38"	50.80	81.79
CF-HN-450	CF4.50"	4.50"	63.50	85.85
CF-HN-462	CF4.62"	4.62"	76.20	89.66
CF-HN-600	CF6.00"	6.00"	101.60	109.73
CF-HN-675	CF6.75"	6.75"	127.00	109.70
CF-HN-800	CF8.00"	8.00"	152.40	139.70
CF-HN-1000	CF10.00"	10.00"	203.20	203.20

CF FLANGE FULL NIPPLES

*MATERIAL: 304 (FLANGES AND TUBES)

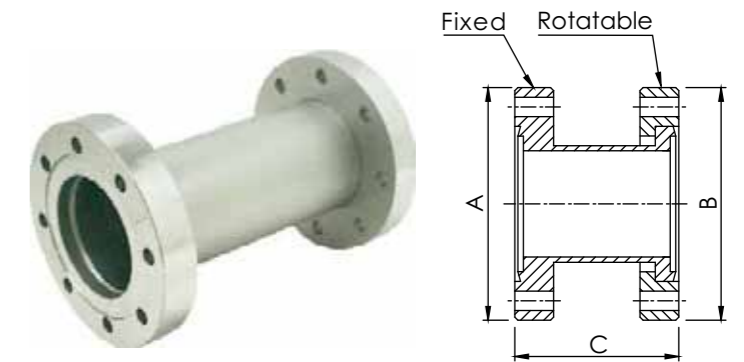

Catalogue PN	Flange Size	A	B	C
CF-FN-133	CF1.33"	1.33"	1.33"	76.20
CF-FN-212	CF2.12"	2.12"	2.12"	104.14
CF-FN-275	CF2.75"	2.75"	2.75"	124.97
CF-FN-338	CF3.38"	3.38"	3.38"	163.58
CF-FN-450	CF4.50"	4.50"	4.50"	171.70
CF-FN-462	CF4.62"	4.62"	4.62"	179.32
CF-FN-600	CF6.00"	6.00"	6.00"	219.46
CF-FN-675	CF6.75"	6.75"	6.75"	214.90
CF-FN-800	CF8.00"	8.00"	8.00"	200.00
CF-FN-1000	CF10.00"	10.00"	10.00"	406.40

CF FLANGES & FITTINGS

CF FLANGE CONICAL REDUCERS

*MATERIAL: 304 (FLANGES AND TUBES)

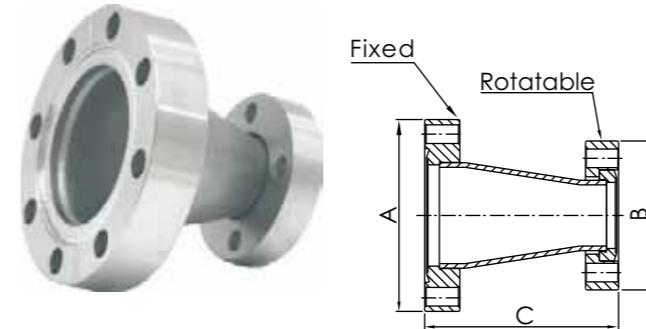

Catalogue PN	Flange Size	A	B	C
CF-CR-212x133	CF2.12"/1.33"	2.12"	1.33"	51.90
CF-CR-275x133	CF2.75"/1.33"	2.75"	1.33"	78.30
CF-CR-275x212	CF2.75"/2.12"	2.75"	2.12"	69.90
CF-CR-338x212	CF3.38"/2.12"	3.38"	2.12"	70.30
CF-CR-338x275	CF3.38"/2.75"	3.38"	2.75"	71.30
CF-CR-450x275	CF4.50"/2.75"	4.50"	2.75"	75.20
CF-CR-450x338	CF4.50"/3.38"	4.50"	3.38"	75.60
CF-CR-462x275	CF4.62"/2.75"	4.62"	2.75"	104.50
CF-CR-462x338	CF4.62"/3.38"	4.62"	3.38"	104.90
CF-CR-462x450	CF4.62"/4.50"	4.62"	4.50"	108.70
CF-CR-600x338	CF6.00"/3.38"	6.00"	3.38"	108.90
CF-CR-600x450	CF6.00"/4.50"	6.00"	4.50"	112.70
CF-CR-600x462	CF6.00"/4.62"	6.00"	4.62"	110.30

CF FLANGE FULL NIPPLES

*MATERIAL: 304 (FLANGES AND TUBES)

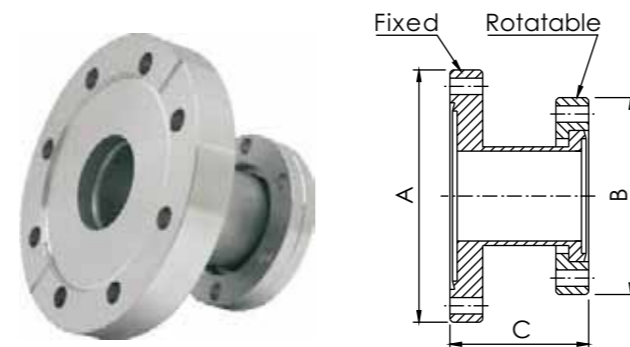

Caatalogue PN	Flange Size	A	B	C
CF-SR-275x133	CF2.75"/1.33"	2.75"	1.33"	45.00
CF-SR-450x133	CF4.50"/1.33"	4.50"	1.33"	70.00
CF-SR-450x275	CF4.50"/2.75"	4.50"	2.75"	75.00
CF-SR-600x275	CF6.00"/2.75"	6.00"	2.75"	127.00
CF-SR-600x450	CF6.00"/4.50"	6.00"	4.50"	95.00
CF-SR-800x275	CF8.00"/2.75"	8.00"	2.75"	127.00
CF-SR-800x450	CF8.00"/4.50"	8.00"	4.50"	127.00
CF-SR-800x600	CF8.00"/6.00"	8.00"	6.00"	127.00
CF-SR-1000x275	CF10.00"/2.75"	10.00"	2.75"	127.00
CF-SR-1000x450	CF10.00"/4.50"	10.00"	4.50"	127.00
CF-SR-1000x600	CF10.00"/6.00"	10.00"	6.00"	127.00
CF-SR-1000x800	CF10.00"/8.00"	10.00"	8.00"	127.00
CF-CR-600x462	CF6.00"/4.62"	6.00"	4.62"	110.30

CF FLANGES & FITTINGS

CF 45° ELBOWS

*MATERIAL: 304 (FLANGES AND TUBES)



Catalogue PN	Flange Size	A
CF-45EL-133	CF1.33"	23.80
CF-45EL-212	CF2.12"	28.90
CF-45EL-275	CF2.75"	44.20
CF-45EL-338	CF3.38"	52.50
CF-45EL-450	CF4.50"	85.60
CF-45EL-462	CF4.62"	100.60
CF-45EL-600	CF6.00"	132.50

CF 90° ELBOWS

*MATERIAL: 304 (FLANGES AND TUBES)



Catalogue PN	Flange Size	A
CF-90EL-133	CF1.33"	38.10
CF-90EL-212	CF2.12"	42.40
CF-90EL-275	CF2.75"	62.50
CF-90EL-338	CF3.38"	81.80
CF-90EL-450	CF4.50"	104.60
CF-90EL-462	CF4.62"	121.40
CF-90EL-600	CF6.00"	163.60

CF 90° ELBOWS

*MATERIAL: 304 (FLANGES AND TUBES)

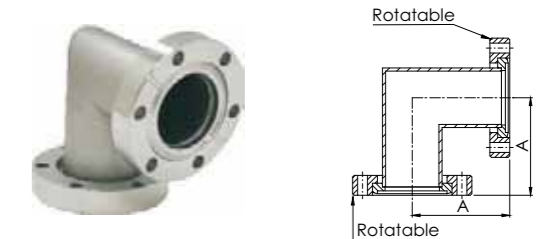

Catalogue PN	Flange Size	A
CF-90EL-133	CF1.33"	38.10
CF-90EL-212	CF2.12"	42.40
CF-90EL-275	CF2.75"	62.50
CF-90EL-338	CF3.38"	81.80
CF-90EL-450	CF4.50"	104.60
CF-90EL-462	CF4.62"	121.40
CF-90EL-600	CF6.00"	163.60

CF FLANGES & FITTINGS

CF EQUAL TEES

*MATERIAL: 304 (FLANGES AND TUBES)

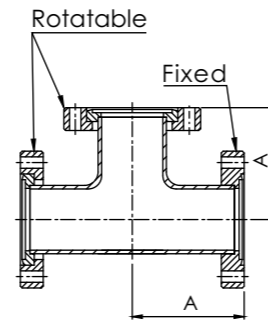

Catalogue PN	Flange Size	A
CF-ET-133	CF1.33"	38.10
CF-ET-212	CF2.12"	52.05
CF-ET-275	CF2.75"	62.50
CF-ET-338	CF3.38"	81.80
CF-ET-450	CF4.50"	85.85
CF-ET-450-L	CF4.50"-L	104.65
CF-ET-462	CF4.62"	89.70
CF-ET-600	CF6.00"	109.70
CF-ET-600-L	CF6.00"-L	134.88

CF EQUAL TEES

*MATERIAL: 304 (FLANGES AND TUBES)

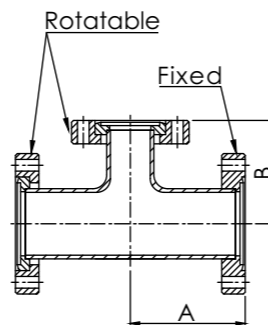

Catalogue PN	Flange Size	A	B
CF-RT-275x133	CF2.75"/1.33"	62.50	47.50
CF-RT-275x212	CF2.75"/2.12"	62.50	58.20
CF-RT-338x133	CF3.38"/1.33"	81.80	54.10
CF-RT-338x275	CF3.38"/2.75"	81.80	68.80
CF-RT-450x275	CF4.50"/2.75"	85.90	75.20
CF-RT-450x338	CF4.50"/3.38"	85.90	88.40
CF-RT-462x338	CF4.62"/3.38"	89.70	94.70
CF-RT-462x450	CF4.62"/4.50"	89.70	92.20
CF-RT-600x275	CF6.00"/2.75"	109.70	94.20
CF-RT-600x338	CF6.00"/3.38"	109.70	107.40
CF-RT-600x450	CF6.00"/4.50"	109.70	104.90
CF-RT-600x462	CF6.00"/4.62"	109.70	102.40

CF FLANGES & FITTINGS

CF 4-WAY CROSSES

*MATERIAL: 304 (FLANGES AND TUBES)
*TUBE FINISH: BEAD BLASTED

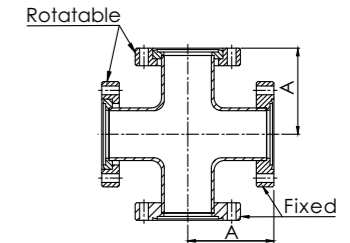

Catalogue PN	Flange Size	A
CF-4C-133	CF1.33"	38.10
CF-4C-212	CF2.12"	52.00
CF-4C-275	CF2.75"	62.50
CF-4C-338	CF3.38"	81.80
CF-4C-450	CF4.50"	85.90
CF-4C-462	CF4.62"	89.70
CF-4C-600	CF6.00"	109.70

CF 4-WAY REDUCING CROSSES

*MATERIAL: 304 (FLANGES AND TUBES)
*TUBE FINISH: BEAD BLASTED

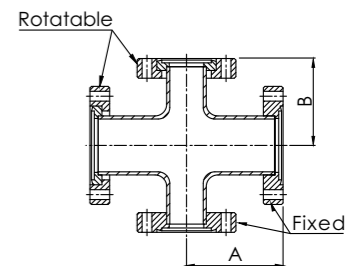

Catalogue PN	Flange Size	A	B
CF-4RC-275x133	CF2.75"/1.33"	62.50	47.50
CF-4RC-275x212	CF2.75"/2.12"	62.50	58.20
CF-4RC-338x133	CF3.38"/1.33"	81.80	54.10
CF-4RC-338x275	CF3.38"/2.75"	81.80	68.80
CF-4RC-450x275	CF4.50"/2.75"	85.90	75.20
CF-4RC-450x338	CF4.50"/3.38"	85.90	88.40
CF-4RC-462x338	CF4.62"/3.38"	89.70	94.70
CF-4RC-462x450	CF4.62"/4.50"	89.70	92.20
CF-4RC-600x275	CF6.00"/2.75"	109.70	94.20
CF-4RC-600x338	CF6.00"/3.38"	109.70	107.40
CF-4RC-600x450	CF6.00"/4.50"	109.70	104.90
CF-4RC-600x462	CF6.00"/4.62"	109.70	104.90



**KF FLANGES &
DN FLANGES
FITTINGS**



KF FLANGE & FITTINGS

GST Clamp flanges are designed in accordance with International Standards Organization specifications which are compatible with other manufacturers' KF-ISO flange design. Standard materials are in stainless steel 304/L and 316/L. Aluminum is also available upon request. KF flanges allow easy and quick disassembly for repeatable uses. Flange connection are available for tube size from 1/2"~2.0". The flanges utilize an aluminum clamp with a single wing nut clamp allowing frequent disassembly without tools. The 15 degree taper surface of flanges allows uniform pressure for compressing an O-ring held in place by a centering ring. The vacuum seal can be applied up to 1 x 10 Torr and baked to 200°C. However, sustained baking above 200°C may result in deterioration of O-rings. King Lai provides a broad range of KF adaptors for connecting to different types of flanges. Please refer to the Adaptor section in this catalogue.

STANDARD SPECIFICATION

Vacuum Rate:
High Vacuum

Materials:
304

Flange Sizes:
KF10~KF50

Tube Sizes:
1/2"~2.0"
Surface Finish: Bead-blasted and polished

Vacuum Range:
760 Torr ~ 1 x 10 Torr

Gasket Materials:
FKM, FFKM

Temperature Range:
<-200°C(150°C sustained)

Cleaning and Packaging

Products with weld joints are 100 percent helium leak tested to assure leak free. To ensure the cleanliness of GST products ready for onsite use, all parts are ultrasonically cleaned with de-ionized water, and packaged in class 10,000 clean room environment. Each bag is affixed with a barcode label identifying the component's part number, heat number and batch number for full traceability.

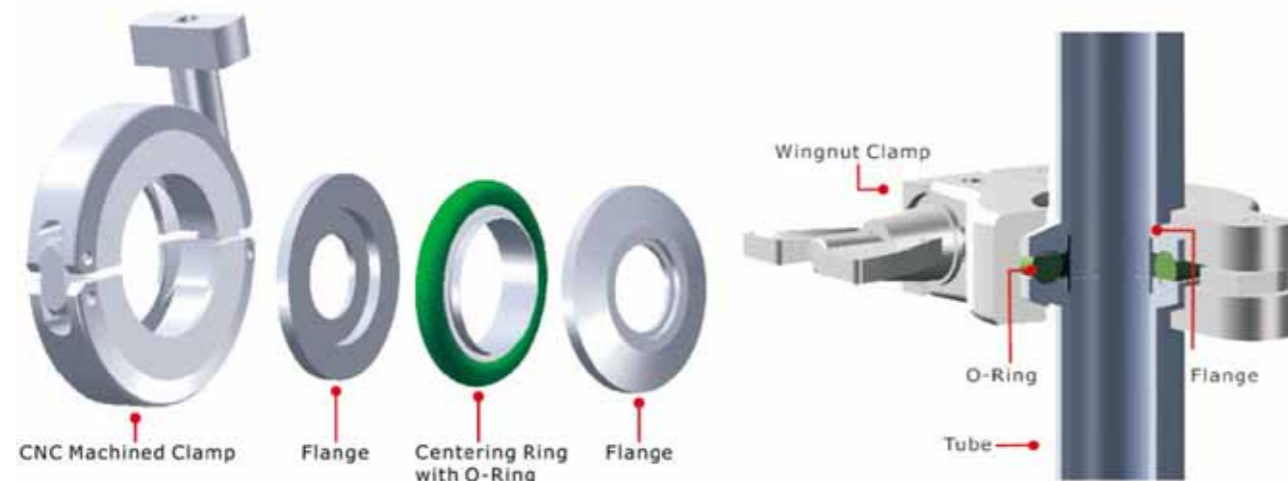

All dimensions are in millimeters unless otherwise specified.

KF FLANGES & FITTINGS

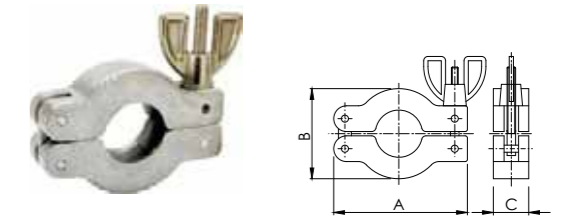

KF WING-NUT CLAMPS TYPE 1

*DIE-CASTING ALUMINUM CLAMP

Catalogue PN	Size	A	B	C
KF-WC1-1016	KF10/16	62.30	41.00	16.50
KF-WC1-25	KF25	72.40	54.00	16.50
KF-WC1-40	KF40	89.70	69.00	16.50
KF-WC1-50	KF50	114.00	90.00	21.50

KF WING-NUT CLAMPS TYPE 2

*DIE-CASTING ALUMINUM CLAMP

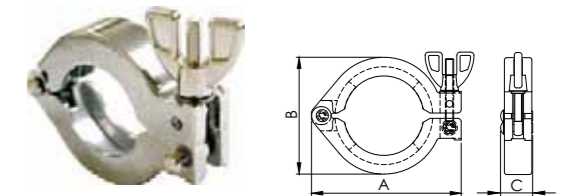

Catalogue PN	Size	A	B	C
KF-WC2-1016	KF10/16	62.70	41.40	19.30
KF-WC2-25	KF25	72.00	53.10	19.30
KF-WC2-40	KF40	90.00	70.20	19.30
KF-WC2-50	KF50	113.40	93.40	22.80

KF FLANGES & FITTINGS

KF BULKHEAD CLAMPS

*MATERIAL: ALUMINUM

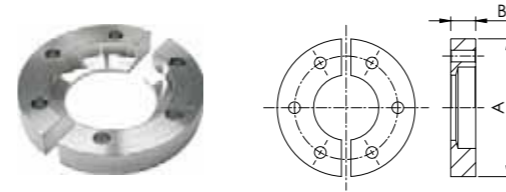

Catalogue PN	Size	A	B	Bolt Hole Size	No of Bolt Holes
KF-BC-16	KF16	50.80	9.20	5.30	6
KF-BC-25	KF25	60.30	9.90	5.30	6
KF-BC-40	KF40	74.60	9.30	5.30	6
KF-BC-50	KF50	95.20	10.30	5.30	8

KF FLANGES & FITTINGS

KF CENTERING RINGS

*MATERIAL: 304

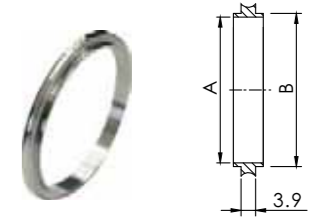

Catalogue PN	Size	A	B
KF-CRN-10	KF10	10.00	12.00
KF-CRN-16	KF16	16.00	17.00
KF-CRN-25	KF25	25.00	26.00
KF-CRN-40	KF40	40.00	41.00
KF-CRN-50	KF50	50.00	52.00

KF CENTERING RINGS, ALUMINUM

*MATERIAL: ALUMINUM

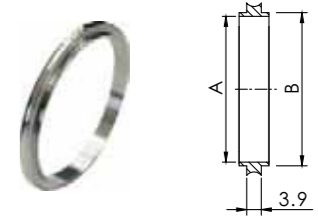

Catalogue PN	Size	A	B
KF-CRN-10-AL	KF10	10.00	12.00
KF-CRN-16-AL	KF16	16.00	17.00
KF-CRN-25-AL	KF25	25.00	26.00
KF-CRN-40-AL	KF40	40.00	41.00
KF-CRN-50-AL	KF50	50.00	52.00

KF CENTERING RINGS with O-RINGS

* CENTERING RING MATERIAL: 304
* O-RING MATERIAL: FKM

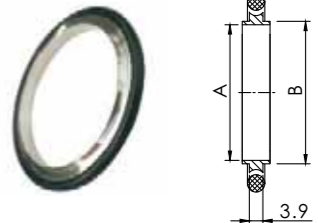

Catalogue PN	Size	A	B
KF-CRO-10	KF10	10.00	12.00
KF-CRO-16	KF16	16.00	17.00
KF-CRO-25	KF25	25.00	26.00
KF-CRO-40	KF40	40.00	41.00
KF-CRO-50	KF50	50.00	52.00

KF CENTERING RINGS with O-RINGS, ALUMINUM

* CENTERING RING MATERIAL: ALUMINUM
* O-RING MATERIAL: FKM



Catalogue PN	Size	A	B
KF-CRO-10-AL	KF10	10.00	12.00
KF-CRO-16-AL	KF16	16.00	17.00
KF-CRO-25-AL	KF25	25.00	26.00
KF-CRO-40-AL	KF40	40.00	41.00
KF-CRO-50-AL	KF50	50.00	52.00

NOTE: 316/L MATERIAL AVAILABLE ON REQUEST.

KF FLANGES & FITTINGS

KF CENTERING RINGS with O-RINGS & SPACERS

*CENTERING RING MATERIAL: 304
*O-RING MATERIAL: FKM
*SPACER MATERIAL: ALUMINUM

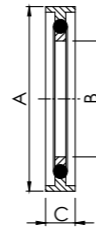

Catalogue PN	Size	A	B	C
KF-CROS-16	KF16	32.50	16.00	7.00
KF-CROS-25	KF25	42.50	25.00	7.00
KF-CROS-40	KF40	57.50	40.00	7.00
KF-CROS-50	KF50	77.50	50.00	7.00

KF ADAPTIVE CENTERING RINGS with O-RINGS

*CENTERING RING MATERIAL: 304
*O-RING: FKM
*70 MESH SCREEN, SCREEN MATERIAL: 304/L

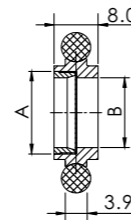

Catalogue PN	Size	A	B
KF-CROSC-16	KF16	15.00	12.70
KF-CROSC-25	KF25	23.80	21.80
KF-CROSC-40	KF40	38.80	36.80
KF-CROSC-50	KF50	50.00	47.75

NOTE: FFKM O-RING MATERIAL AVAILABLE ON REQUEST.

KF FLANGES & FITTINGS

KF OVER PRESSURE RINGS

*MATERIAL: 304

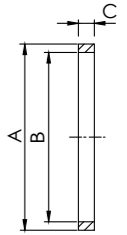

Catalogue PN	Size	A	B	C
KF-OR-10	KF 10	31.80	27.70	3.60
KF-OR-16	KF 16	31.80	29.90	3.60
KF-OR-25	KF 25	41.90	39.10	3.60
KF-OR-40	KF 40	57.20	54.50	3.60
KF-OR-50	KF 50	69.90	67.60	3.60

KF REPLACEMENT O-RINGS

*MATERIAL: FKM

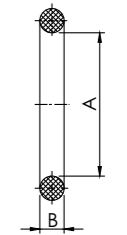

Catalogue PN	Size	A	B
KF-RO-10	KF 10	15.24	5.33
KF-RO-16	KF 16	18.42	5.33
KF-RO-25	KF 25	27.94	5.33
KF-RO-40	KF 40	40.64	5.33
KF-RO-50	KF 50	53.34	5.33

NOTE: FFKM O-RING MATERIAL AVAILABLE ON REQUEST.

KF REPLACEMENT O-RINGS

*MATERIALS: PE

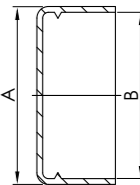

Catalogue PN	Size	A	B
KF-PC-1016	KF10/ KF16	32.00	30.00
KF-PC-25	KF25	42.00	40.00
KF-PC-40	KF40	57.00	55.00
KF-PC-50	KF50	77.00	75.00

KF FLANGES & FITTINGS

KF BLANK FLANGES

*MATERIAL: 304

Catalogue PN	Size	A	B
KF-BL-10	KF10	30.00	5.10
KF-BL-16	KF16	30.00	5.10
KF-BL-25	KF25	40.00	5.10
KF-BL-40	KF40	55.00	5.10
KF-BL-50	KF50	75.00	5.10

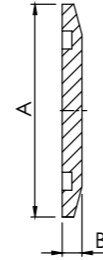

KF BORED FLANGES

*MATERIAL: 304

Catalogue PN	Size	Diagram	A	B	C	D	E
KF-BF-10x038	KF 10-3/8"	A	30.00	12.20	-	9.65	5.10
KF-BF-16x025	KF16-1/4"	A	30.00	17.20	-	6.50	5.10
KF-BF-16x038	KF16-3/8"	A	30.00	17.20	-	9.65	5.10
KF-BF-16x050	KF16-1/2"	B	30.00	17.20	10.16	12.95	5.10
KF-BF-16x075	KF16-3/4"	B	30.00	17.20	16.51	19.30	4.40
KF-BF-25x025	KF25-1/4"	A	40.00	26.20	-	6.50	5.10
KF-BF-25x038	KF25-3/8"	A	40.00	26.20	-	9.65	5.10
KF-BF-25x050	KF25-1/2"	B	40.00	26.20	10.16	12.95	5.10
KF-BF-25x075	KF25-3/4"	B	40.00	26.20	16.51	19.30	5.10
KF-BF-25x100	KF25-1.0"	B	40.00	26.20	22.88	25.65	4.90
KF-BF-40x025	KF40-1/4"	A	55.00	41.20	-	6.50	5.10
KF-BF-40x038	KF40-3/8"	A	55.00	41.20	-	9.65	5.10
KF-BF-40x050	KF40-1/2"	B	55.00	41.20	10.16	12.95	5.10
KF-BF-40x075	KF40-3/4"	B	55.00	41.20	16.51	19.30	5.10
KF-BF-40x100	KF40-1.0"	B	55.00	41.20	22.88	25.65	5.10
KF-BF-40x150	KF40-1.5"	B	55.00	41.20	35.58	38.35	5.10
KF-BF-50x025	KF50-1/4"	A	75.00	52.20	-	6.50	5.10
KF-BF-50x038	KF50-3/8"	A	75.00	52.20	-	9.65	5.10
KF-BF-50x050	KF50-1/2"	B	75.00	52.20	10.16	12.95	5.10
KF-BF-50x075	KF50-3/4"	B	75.00	52.20	16.51	19.30	5.10
KF-BF-50x100	KF50-1.0"	B	75.00	52.20	22.88	25.65	5.10
KF-BF-50x150	KF50-1.5"	B	75.00	52.20	35.58	38.35	5.10
KF-BF-50x200	KF50-2.0"	B	75.00	52.20	48.26	51.05	5.10

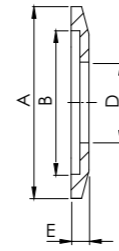

Diagram A

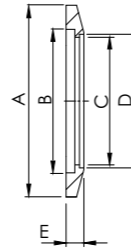

Diagram B

KF FLANGES & FITTINGS

KF SOCKET WELD FLANGES, SHORT

*MATERIAL: 304

Catalogue PN	Size	A	B	C	D	E
KF-SWS-10	KF10	30.00	12.20	12.90	16.00	6.35
KF-SWS-16	KF16	30.00	17.20	19.30	22.40	6.35
KF-SWS-25	KF25	40.00	26.20	25.70	28.80	6.35
KF-SWS-40	KF40	55.00	41.20	38.40	41.50	6.35
KF-SWS-50	KF50	75.00	52.20	51.10	54.20	6.35

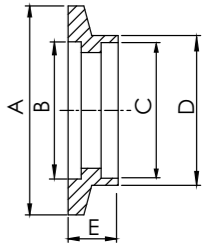

KF SOCKET WELD FLANGES, LONG

*MATERIAL: 304

Catalogue PN	Size	A	B	C	D	E
KF-SWL-10	KF10	30.00	12.20	13.00	15.50	12.70
KF-SWL-16	KF16	30.00	17.20	19.30	22.20	12.70
KF-SWL-25	KF25	40.00	26.20	25.90	28.60	12.70
KF-SWL-40	KF40	55.00	41.20	38.60	44.50	12.70
KF-SWL-50	KF50	75.00	52.20	51.30	57.20	12.70

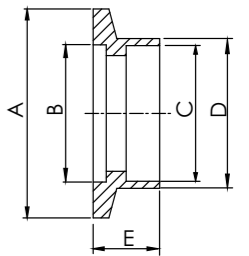

KF SOCKET WELD FLANGES, LONG

*MATERIAL: 304

Catalogue PN	Size	A	B	C	D	E
KF-BWS-10	KF10	30.00	12.20	9.40	12.70	12.70
KF-BWS-16	KF16	30.00	12.70	15.70	19.10	12.70
KF-BWS-25	KF25	40.00	26.20	22.10	25.40	12.70
KF-BWS-40	KF40	55.00	41.20	34.80	38.10	19.10
KF-BWS-50	KF50	75.00	52.20	47.50	50.80	19.10

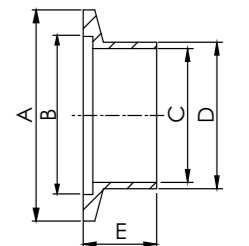

KF FLANGES & FITTINGS

KF BUTT WELD STUB FLANGES, LONG

*MATERIAL: 304

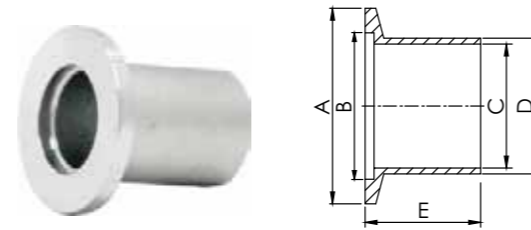

Catalogue PN	Size	A	B	C	D	E
KF-BWL-10	KF10	30.00	12.20	9.40	12.70	40.00
KF-BWL-1016	K10/16	30.00	17.20	9.40	12.70	40.00
KF-BWL-16	KF16	30.00	17.20	15.75	19.05	40.00
KF-BWL-25	KF25	40.00	26.20	22.10	25.40	40.00
KF-BWL-40	KF40	55.00	41.20	34.90	38.10	40.00
KF-BWL-50	KF50	75.00	52.20	47.60	50.80	40.00

KF HALF NIPPLES

*MATERIAL: 304

Catalogue PN	Size	Diagram	A	B	C	D	E
KF-HN-10	KF 10-1.25"	A	30.00	12.20	9.40	12.70	31.75
KF-HN-16	KF 16-1.15"	A	30.00	17.20	15.80	19.10	29.21
KF-HN-16-1	KF 16-1.50"	A	30.00	17.20	15.80	19.10	38.10
KF-HN-25	KF 25-2.03"	B	40.00	26.20	22.10	25.40	51.56
KF-HN-25-1	KF 25-2.04"	A	40.00	26.20	22.10	25.40	51.80
KF-HN-40	KF40-2.40"	B	55.00	41.20	34.80	38.10	60.96
KF-HN-40-1	KF40-2.46"	B	55.00	41.20	34.80	38.10	62.50
KF-HN-50	KF50-3.15"	B	75.00	52.20	47.50	50.80	80.01
KF-HN-50-1	KF50-3.21"	B	75.00	52.20	47.50	50.80	81.50

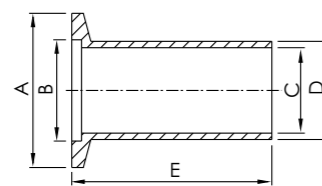

Diagram A
Machined

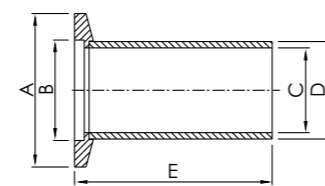
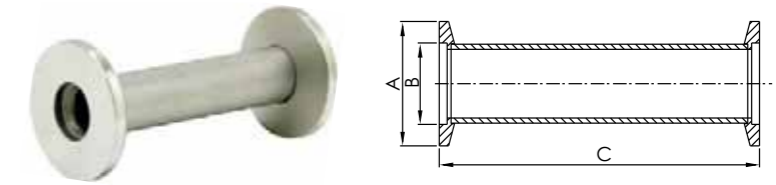

Diagram B
Welded

KF FLANGES & FITTINGS

KF FULL NIPPLES

*MATERIAL: 304



Catalogue PN	Size	A	B	C
KF-FN-10	KF10-2.50"	30.00	12.20	63.50
KF-FN-16	KF16-2.30"	30.00	17.20	58.40
KF-FN-25	KF25-4.00"	40.00	26.20	103.10
KF-FN-40	KF40-4.80"	55.00	41.20	121.90
KF-FN-50	KF50-6.30"	75.00	52.20	160.00

KF FULL NIPPLES, LONG

*MATERIAL: 304/L

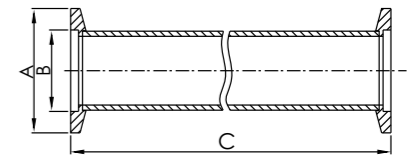

Catalogue PN	Size	A	B	C
KF-FNL-16	KF16-12.60"	30.00	17.20	320.00
KF-FNL-25	KF25-12.60"	40.00	26.20	320.00
KF-FNL-40	KF40-12.60"	55.00	41.20	320.00
KF-FNL-50	KF50-12.60"	75.00	52.20	320.00

KF FLANGES & FITTINGS

KF STRAIGHT REDUCERS

*MATERIAL: 304

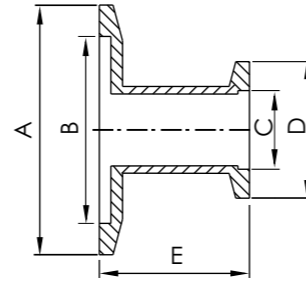

Catalogue PN	Size	A	B	C	D	E
KF-SRN-25x16	KF25 X KF16	40.00	26.20	17.20	30.00	43.20
KF-SRN-40x16	KF40 X KF16	55.00	41.20	17.20	30.00	43.20
KF-SRN-40x25	KF40 X KF25	55.00	41.20	26.20	40.00	43.20
KF-SRN-50x16	KF50 X KF16	75.00	52.20	17.20	30.00	43.20
KF-SRN-50x25	KF50X KF25	75.00	52.20	26.20	40.00	43.20
KF-SRN-50x40	KF50 X KF40	75.00	52.20	41.20	55.00	43.20

KF CONICAL REDUCERS

*MATERIAL: 304

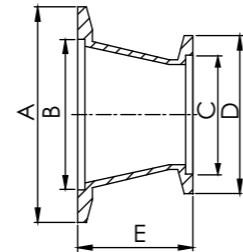

Catalogue PN	Size	A	B	C	D	E
KF-CRN-25x16	KF25xKF16	40.00	26.20	17.20	30.00	39.90
KF-CRN-40x16	KF40xKF16	55.00	41.20	17.20	30.00	39.90
KF-CRN-40x25	KF40xKF25	55.00	41.20	26.20	40.00	39.90
KF-CRN-50x16	KF50xKF16	75.00	52.20	17.20	30.00	39.90
KF-CRN-50x25	KF50xKF25	75.00	52.20	26.20	40.00	39.90
KF-CRN-50x40	KF50xKF40	75.00	52.20	41.20	55.00	39.90

KF FLANGES & FITTINGS

KF 45° ELBOWS

*MATERIAL: 304

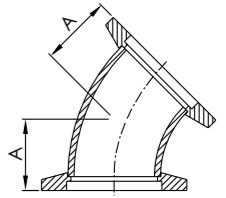

Catalogue PN	Size	A
KF-45EL-16	KF16	15.65
KF-45EL-25	KF25	19.58
KF-45EL-40	KF40	27.47
KF-45EL-50	KF50	35.36

KF 45° ELBOWS with TANGENTS

*MATERIAL: 304

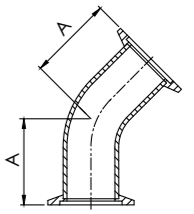

Catalogue PN	Size	A
KF-45ELT-16	KF16	23.10
KF-45ELT-25-S	KF25-S	28.45
KF-45ELT-25	KF25	33.88
KF-45ELT-40-S	KF40-S	42.67
KF-45ELT-40	KF40	45.10
KF-45ELT-50-S	KF50-S	50.55
KF-45ELT-50	KF50	62.50

KF 90° ELBOWS

*MATERIAL: 304

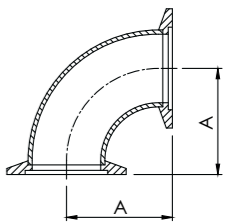

Catalogue PN	Size	A
KF-90EL-10	KF10	31.80
KF-90EL-16	KF16	29.20
KF-90EL-25	KF25	41.90
KF-90EL-40	KF40	61.00
KF-90EL-50	KF50	80.00

KF FLANGES & FITTINGS

KF 90° ELBOWS with TANGENTS

*MATERIAL: 304

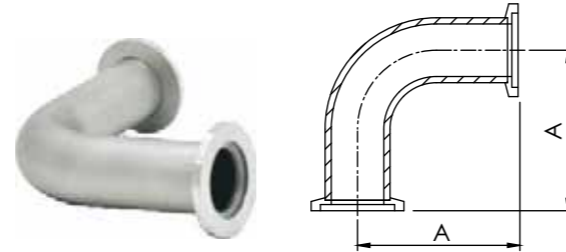

Catalogue PN	Size	A
KF-90ELT-16	KF16	68.58
KF-90ELT-25	KF25	92.46
KF-90ELT-40	KF40	130.05
KF-90ELT-50	KF50	139.95

KF 90° ELBOWS with TANGENTS

*MATERIAL: 304

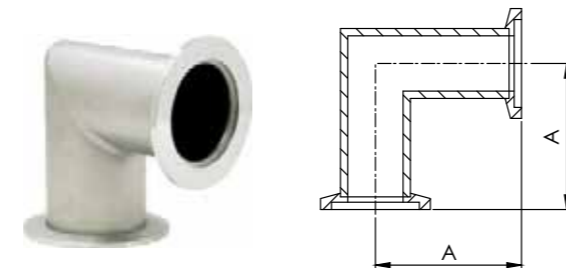

Catalogue PN	Size	A
KF-MEL-16	KF16	29.21
KF-MEL-16-H	KF16-H	40.00
KF-MEL-25	KF25	50.00
KF-MEL-25-H	KF25-H	51.56
KF-MEL-40	KF40	60.96
KF-MEL-40-H	KF40-H	65.00
KF-MEL-50	KF50	69.84
KF-MEL-50-H	KF50-H	80.01

KF FLANGES & FITTINGS

KF EQUAL TEES

*MATERIAL: 304

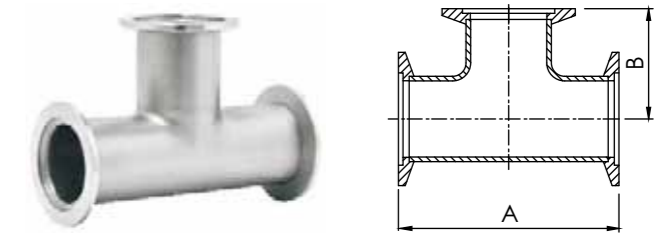

Catalogue PN	Size	A	B
KF-ET-10	KF10	63.50	31.75
KF-ET-16	KF16	58.40	29.20
KF-ET-16-H	KF16-H	80.00	40.00
KF-ET-25	KF25	100.00	50.00
KF-ET-25-H	KF25-H	102.80	51.40
KF-ET-40	KF40	122.00	61.00
KF-ET-40-H	KF40-H	130.00	65.00
KF-ET-50	KF50	140.00	70.00
KF-ET-50-H	KF50-H	160.00	80.00

KF REDUCING TEES

*MATERIAL: 304

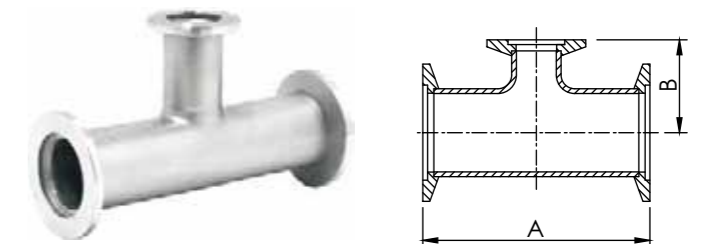

Catalogue PN	Size	A	B
KF-RT-25x16	KF25 x KF16	100.00	27.80
KF-RT-25x16-1	KF25 x KF16	100.00	43.20
KF-RT-25x16-2	KF25 x KF16	103.10	32.25
KF-RT-40x16	KF40 x KF16	121.90	38.85
KF-RT-40x16-1	KF40 x KF16	130.00	34.00
KF-RT-40x16-2	KF40 x KF16	130.00	49.50
KF-RT-40x25	KF40 x KF25	121.90	57.91
KF-RT-40x25-1	KF40 x KF25	130.00	56.40
KF-RT-50x16	KF50 x KF16	140.00	40.10
KF-RT-50x16-1	KF50 x KF16	140.00	55.90
KF-RT-50x16-2	KF50 x KF16	160.00	45.20
KF-RT-50x25	KF50 x KF25	140.00	62.70
KF-RT-50x40	KF50 x KF40	140.00	71.40
KF-RT-50x40-1	KF50 x KF40	160.00	67.31

KF FLANGES & FITTINGS

KF 4-WAY CROSSES

*MATERIAL: 304

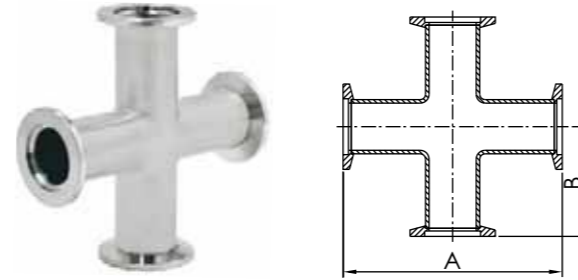

Catalogue PN	Size	A	B
KF-4C-10	KF10	63.50	31.75
KF-4C-16	KF16	58.40	29.20
KF-4C-16-H	KF16-H	80.00	40.00
KF-4C-25	KF25	100.00	50.00
KF-4C-25-H	KF25-H	102.80	51.40
KF-4C-40	KF40	122.00	61.00
KF-4C-40-H	KF40-H	130.00	65.00
KF-4C-50	KF50	140.00	70.00
KF-4C-50-H	KF50-H	160.00	80.00

KF REDUCING 4-WAY CROSSES

*MATERIAL: 304

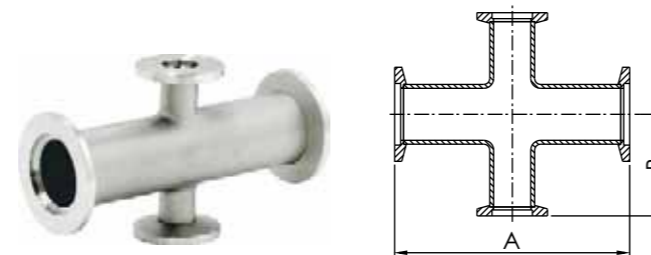

Catalogue PN	Size	A	B
KF-4RC-25x16	KF25 x KF16	100.00	43.20
KF-4RC-25x16-H	KF25 x KF16-H	103.12	32.26
KF-4RC-40x16	KF40 x KF16	121.92	38.86
KF-4RC-40x16-H	KF40 x KF16-H	130.00	49.50
KF-4RC-40x25	KF40 x KF25	121.92	57.91
KF-4RC-40x25-H	KF40 x KF25-H	130.00	56.40
KF-4RC-50x16	KF50 x KF16	140.00	55.90
KF-4RC-50x16-H	KF50 x KF16-H	160.02	45.21
KF-4RC-50x25-H	KF50 x KF25-H	140.00	62.70
KF-4RC-50x40	KF50 x KF40	140.00	71.40
KF-4RC-50x40-H	KF50 x KF40-H	160.02	67.31

KF FLANGES & FITTINGS

DN BUTT WELD STUBS, LENGTH 26MM

*MATERIAL: 304

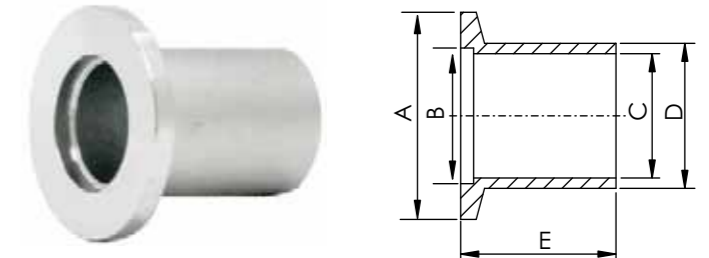

Catalogue PN	Size	A	B	C	D	E
DN-BW26-10	DN10	30.00	12.20	10.00	14.00	26.00
DN-BW26-16	DN16	30.00	17.20	16.00	20.00	26.00
DN-BW26-20	DN20	40.00	22.20	21.00	25.00	26.00
DN-BW26-25	DN25	40.00	26.20	24.00	28.00	26.00
DN-BW26-32	DN32	55.00	34.20	34.00	38.00	26.00
DN-BW26-40	DN40	55.00	41.20	40.50	44.50	26.00
DN-BW26-50	DN50	75.00	52.20	50.60	57.00	26.00

DN BUTT WELD STUBS, LENGTH 26MM

*MATERIAL: 304

Catalogue PN	Size	A	B	C	D	E
DN-BW30-10	DN10	30.00	12.20	10.00	14.00	30.00
DN-BW30-16	DN16	30.00	17.20	16.00	20.00	30.00
DN-BW30-25	DN25	40.00	26.20	24.00	28.00	30.00
DN-BW30-40	DN40	55.00	41.20	40.50	44.50	30.00
DN-BW30-50	DN50	75.00	52.20	50.60	57.00	30.00

DN BUTT WELD STUBS, LENGTH 26MM

*MATERIAL: 304

Catalogue PN	Size	A	B	C	D	E
DN-BW55-10	DN10	30.00	12.20	10.00	14.00	55.00
DN-BW55-16	DN16	30.00	17.20	16.00	20.00	55.00
DN-BW55-25	DN25	40.00	26.20	24.00	28.00	55.00
DN-BW55-40	DN40	55.00	41.20	40.50	44.50	55.00
DN-BW55-50	DN50	75.00	52.20	50.60	57.00	55.00

DN BUTT WELD STUBS, LENGTH 26MM

*MATERIAL: 304

Catalogue PN	Size	A	B	C	D	E
DN-BW70-10	DN10	30.00	12.20	10.00	14.00	70.00
DN-BW70-16	DN16	30.00	17.20	16.00	20.00	70.00
DN-BW70-25	DN25	40.00	26.20	24.00	28.00	70.00
DN-BW70-40	DN40	55.00	41.20	40.50	44.50	70.00
DN-BW70-50	DN50	75.00	52.20	50.60	57.00	70.00

KF FLANGES & FITTINGS

DN STRAIGHT REDUCERS, SHORT

*MATERIAL: 304

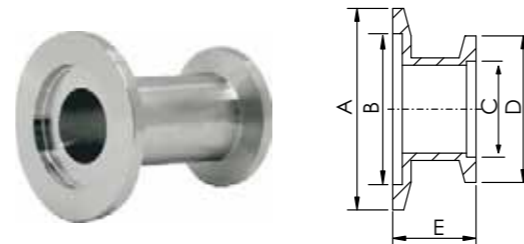

Catalogue PN	Size	A	B	C	D	E
DN-SRNS-16x10	DN16xDN10	30.00	17.20	12.20	30.00	28.00
DN-SRNS-25x10	DN25xDN10	40.00	26.20	12.20	30.00	28.00
DN-SRNS-25x16	DN25xDN16	40.00	26.20	17.20	30.00	28.00
DN-SRNS-40x10	DN40xDN10	55.00	41.20	12.20	30.00	28.00
DN-SRNS-40x16	DN40xDN16	55.00	41.20	17.20	30.00	28.00
DN-SRNS-40x25	DN40xDN25	55.00	41.20	26.20	40.00	28.00
DN-SRNS-50x16	DN50xDN16	75.00	52.20	17.20	30.00	28.00
DN-SRNS-50x25	DN50xDN25	75.00	52.20	26.20	40.00	28.00
DN-SRNS-50x40	DN50xDN40	75.00	52.20	41.20	55.00	28.00

DN STRAIGHT REDUCERS, LONG

*MATERIAL: 304

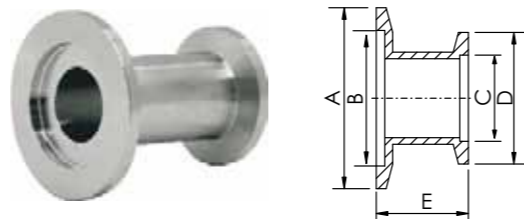

Catalogue PN	Size	A	B	C	D	E
DN-SRNL-25x16	DN25xDN16	40.00	26.20	17.20	30.00	40.00
DN-SRNL-40x16	DN40xDN16	55.00	41.20	17.20	30.00	40.00
DN-SRNL-40x25	DN40xDN25	55.00	41.20	26.20	40.00	40.00
DN-SRNL-50x16	DN50xDN16	75.00	52.20	17.20	30.00	40.00
DN-SRNL-50x25	DN50xDN25	75.00	52.20	26.20	40.00	40.00
DN-SRNL-50x40	DN50xDN40	75.00	52.20	41.20	55.00	40.00

DN CONICAL REDUCERS

*MATERIAL: 304

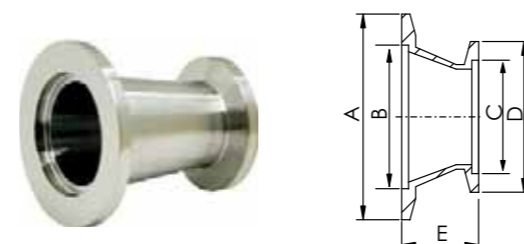

Catalogue PN	Size	A	B	C	D	E
DN-CRN-25x16	DN25xDN16	40.00	26.20	17.20	30.00	28.00
DN-CRN-40x16	DN40xDN16	55.00	41.20	17.20	30.00	28.00
DN-CRN-40x25	DN40xDN25	55.00	41.20	26.20	40.00	28.00
DN-CRN-50x16	DN50xDN16	75.00	52.40	17.20	30.00	28.00
DN-CRN-50x25	DN50xDN25	75.00	52.40	26.20	40.00	28.00
DN-CRN-50x40	DN50xDN40	75.00	52.40	41.20	55.00	28.00

KF FLANGES & FITTINGS

DN 45° ELBOWS WITH TANGENTS

*MATERIAL: 304

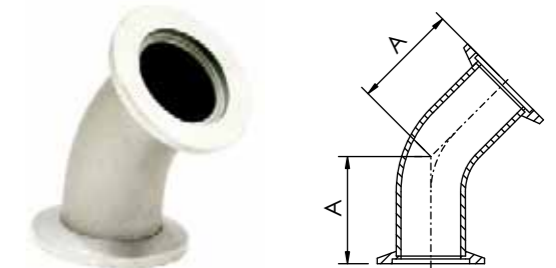

Catalogue PN	Size	A	Tube Size
DN-45ELT-10	DN10	30.00	14.0 X 2.0mmt
DN-45ELT-16	DN16	26.00	20.0 X 1.5mmt
DN-45ELT-25	DN25	32.00	28.0 X 1.5mmt
DN-45ELT-40	DN40	40.00	44.5 X 2.0mmt
DN-45ELT-50	DN50	51.00	54.0 X 2.0mmt

DN 90° ELBOWS

*MATERIAL: 304

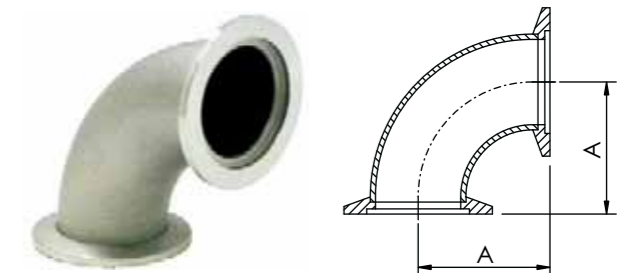

Catalogue PN	Size	A	Tube Size
DN-90EL-10	DN10	30.00	14.0 x 2.0mmt
DN-90EL-16	DN16	40.00	20.0 x 1.5mmt
DN-90EL-25	DN25	50.00	28.0 x 1.5mmt
DN-90EL-40	DN40	65.00	44.5 x 2.0mmt
DN-90EL-50	DN50	70.00	54.0 x 2.0mmt

KF FLANGES & FITTINGS

DN EQUAL TEES

*MATERIAL: 304

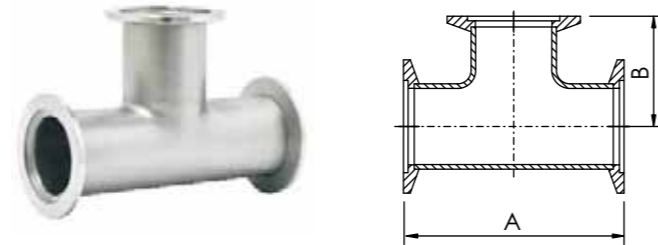

Catalogue PN	Size	A	B	Tube Size
DN-ET-10	DN10	60.00	30.00	14.0 x 2.0mmt
DN-ET-16	DN16	80.00	40.00	20.0 x 1.5mmt
DN-ET-25	DN25	100.00	50.00	28.0 x 1.5mmt
DN-ET-40	DN40	130.00	65.00	44.5 x 2.0mmt
DN-ET-50	DN50	140.00	70.00	54.0 x 2.0mmt
DN-ET-57	DN57	140.00	70.00	57.0 x 3.0mmt

DN REDUCING TEES

*MATERIAL: 304

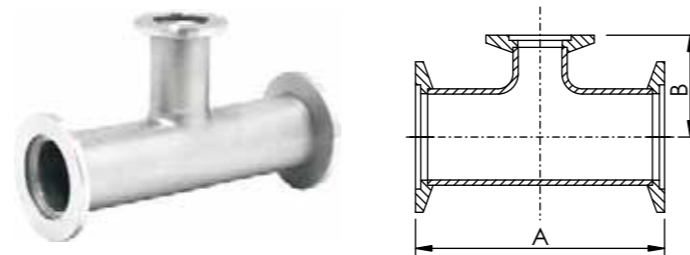

Catalogue PN	Size	A	B	Tube Size 1	Tube Size 2
DN-RT-25x10	DN25 x DN10	100.00	40.00	28.0 x 1.5mmt	14.0 x 2.0mmt
DN-RT-25x16	DN25 x DN16	100.00	40.00	28.0 x 1.5mmt	20.0 x 1.5mmt
DN-RT-40x16	DN40 x DN16	130.00	40.00	44.5 x 2.0mmt	20.0 x 1.5mmt
DN-RT-40x25	DN40 x DN25	130.00	50.00	44.5 x 2.0mmt	28.0 x 1.5mmt
DN-RT-50x16	DN50 x DN16	140.00	50.00	20.0 x 1.5mmt	20.0 x 1.5mmt
DN-RT-50x25	DN50 x DN25	140.00	65.00	54.0 x 2.0mmt	28.0 x 1.5mmt
DN-RT-50x40	DN50 x DN40	140.00	65.00	54.2 x 2.0mmt	44.5 x 2.0mmt
DN-RT-57x16	DN57 x DN16	140.00	50.00	57.0 x 3.0mmt	20.0 x 1.5mmt
DN-RT-57x25	DN57 x DN25	140.00	65.00	57.0 x 3.0mmt	28.0 x 1.5mmt
DN-RT-57x40	DN57 x DN40	140.00	65.00	57.0 x 3.0mmt	44.5 x 2.0mmt

KF FLANGES & FITTINGS

DN 4-WAY CROSSES

*MATERIAL: 304

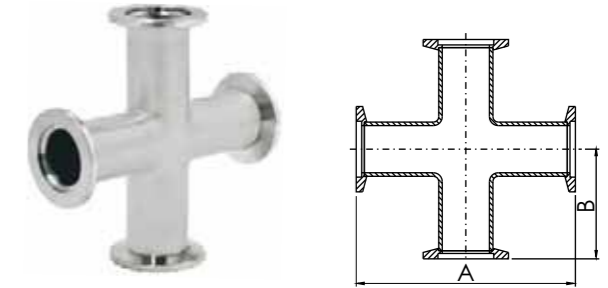

Catalogue PN	Size	A	B	Tube Size
DN-4C-10	DN10	60.00	30.00	14.0 x 2.0mmt
DN-4C-16	DN16	80.00	40.00	20.0 x 1.5mmt
DN-4C-25	DN25	100.00	50.00	28.0 x 1.5mmt
DN-4C-40	DN40	130.00	65.00	44.5 x 2.0mmt
DN-4C-50	DN50	140.00	70.00	54.0 x 2.0mmt
DN-4C-57	DN57	140.00	70.00	57.0 x 3.0mmt

DN 4-WAY CROSSES

*MATERIAL: 304

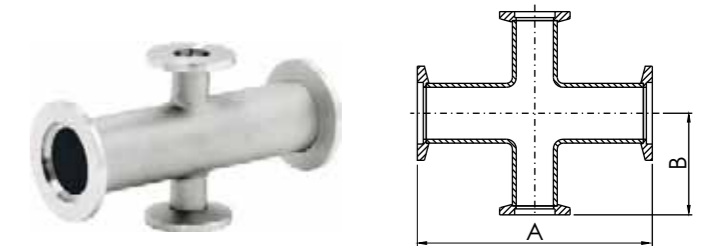

Catalogue PN	Size	A	B	Tube Size 1	Tube Size 2
DN-4RC-25x10	DN25 x DN10	100.00	40.00	28.0 x 1.5mmt	14.0 x 2.0mmt
DN-4RC-25x16	DN25 x DN16	100.00	40.00	28.0 x 1.5mmt	20.0 x 1.5mmt
DN-4RC-40x10	DN40 x DN10	130.00	40.00	44.5 x 2.0mmt	14.0 x 2.0mmt
DN-4RC-40x16	DN40 x DN16	130.00	40.00	44.5 x 2.0mmt	20.0 x 1.5mmt
DN-4RC-40x25	DN40 x DN25	130.00	50.00	44.5 x 2.0mmt	28.0 x 1.5mmt
DN-4RC-50x16	DN50 x DN16	140.00	50.00	54.0 x 2.0mmt	20.0 x 1.5mmt
DN-4RC-50x25	DN50 x DN25	140.00	50.00	54.0 x 2.0mmt	28.0 x 1.5mmt
DN-4RC-50x40	DN50 x DN40	140.00	65.00	54.0 x 2.0mmt	44.5 x 2.0mmt
DN-4RC-57x16	DN57 x DN16	140.00	50.00	57.0 x 3.0mmt	20.0 x 1.5mmt
DN-4RC-57x25	DN57 x DN25	140.00	50.00	57.0 x 3.0mmt	28.0 x 1.5mmt
DN-4RC-57x40	DN57 x DN40	140.00	65.00	57.0 x 3.0mmt	44.5 x 2.0mmt



ISO FLANGES & FITTINGS



ISO FLANGE & FITTINGS

ISO flanges are designed to fit tubes with OD above 2 inches. ISO flange are manufactured according to ISO specifications with full compatibility to other manufacturers' standard. There are two types of flange assemblies, claw clamp type and bolt flange type; both use an O-ring hold in place by a centering ring to achieve vacuum seal up to 1 x 10 Torr. The bolt type flanges are assembled by using a set of bolts to fix the position of the flanges. The claw clamp flanges use double claw clamps to hold two flanges together. The use of the claw clamps means that mating flanges can be connected together in any orientation. Wide ranges of adaptors for connection to CF or KF are in the Adaptor Section.

STANDARD SPECIFICATION

Vacuum Rate:
High Vacuum

Materials:
304

Flange Sizes:
ISO63~ISO320

Tube Sizes:
1/2"~6.0"

Vacuum Range:
760 Torr ~ 1 x 10 Torr

Gasket Materials:
FKM, FFKM

Temperature Range:
<-200°C(150°C sustained)

Cleaning and Packaging

Products with weld joins are 100 percent helium leak tested to assure leak free. To ensure the cleanliness of GST products ready for onsite use, all part are ultrasonically cleaned with de- ionized water, and packaged in class 10,000 clean room environment. Each bag is affixed with a barcode label identifying the component's part number, heat number and batch number for full traceability.

ISO FLANGES & FITTINGS

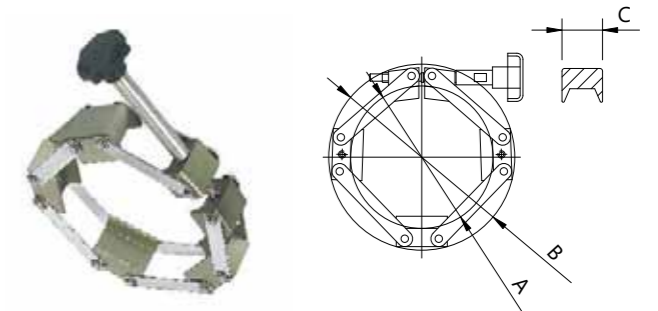

NW CHAIN CLAMPS

*MATERIALS: ALUMINUM

Catalogue PN	Size	A	B	C
NW-CC-63	NW63	98.00	134.40	30.00
NW-CC-80	NW80	117.10	153.00	30.00
NW-CC-100	NW100	136.50	171.68	30.00
NW-CC-160	NW160	197.90	231.70	30.00

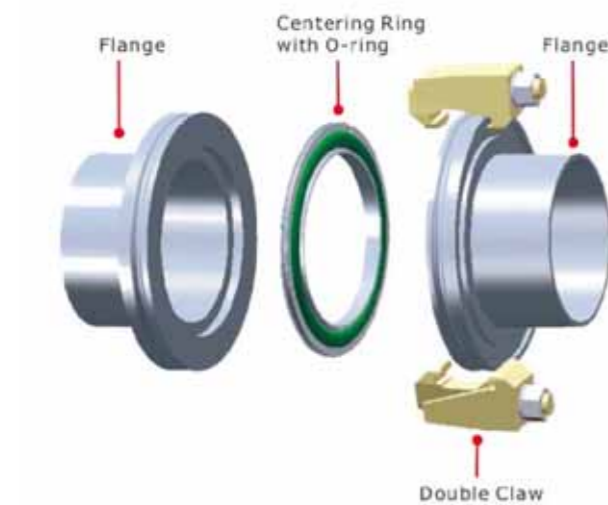

Clamp Type Flange Assembly

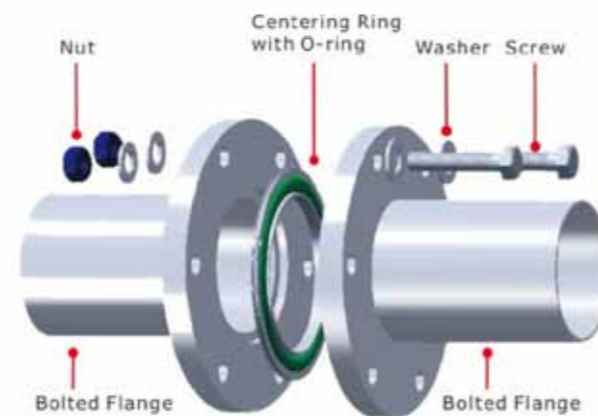

Bolt Type Flange Assembly

All dimensions are in millimeters unless otherwise specified.

ISO-K DOUBLE CLAWS

*MATERIAL: ALUMINUM

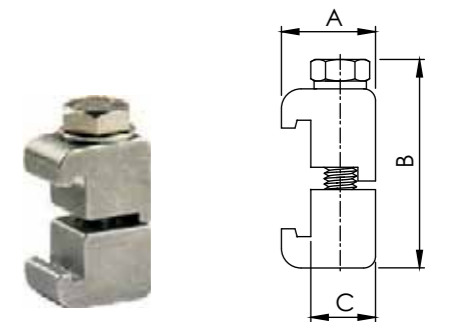

Catalogue PN	Size	A	B	C	Thread Size
ISOK-DC-63100M-AL	ISO63-ISO100	24.00	50.00	16.50	M8x45L
ISOK-DC-63100-AL	ISO63-ISO100	24.00	50.00	16.50	5/16"-18
ISOK-DC-160250M-AL	ISO160-ISO250	27.50	51.60	20.00	M10x45L
ISOK-DC-160250-AL	ISO160-ISO250	27.50	51.60	20.00	5/16"-18

ISO FLANGES & FITTINGS

ISO CENTERING RINGS

*MATERIAL: 304

Catalogue PN	Size	A	B	C	D
ISO-CR-63	ISO63	68.00	70.00	3.90	8
ISO-CR-80	ISO80	81.00	83.00	3.90	8
ISO-CR-100	ISO100	100.00	102.00	3.90	8
ISO-CR-160	ISO160	151.00	153.00	3.90	8
ISO-CR-200	ISO200	210.00	213.00	3.90	8
ISO-CR-250	ISO250	256.00	261.00	3.90	8
ISO-CR-320	ISO320	311.15	316.48	5.50	14

NOTE: 316/L MATERIAL AVAILABLE ON REQUEST.

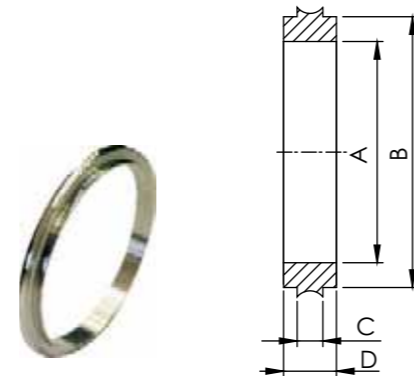

ISO CENTERING RINGS, ALUMINUM

*MATERIAL: ALUMINUM

Catalogue PN	Size	A	B	C	D
ISO-CR-63-AL	ISO63	68.00	70.00	3.90	8
ISO-CR-80-AL	ISO80	81.00	83.00	3.90	8
ISO-CR-100-AL	ISO100	100.00	102.00	3.90	8
ISO-CR-160-AL	ISO160	151.00	153.00	3.90	8
ISO-CR-200-AL	ISO200	210.00	213.00	3.90	8
ISO-CR-250-AL	ISO250	256.00	261.00	3.90	8
ISO-CR-320-AL	ISO320	311.15	316.48	5.50	14

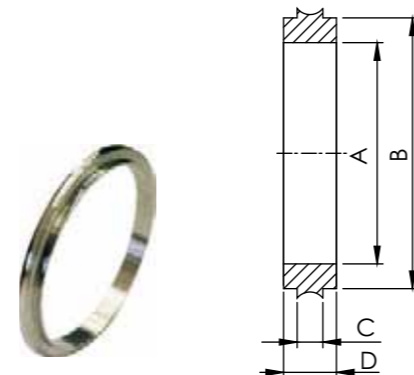

ISO FLANGES & FITTINGS

ISO CENTERING RINGS with O-RINGS

*CENTERING RING MATERIAL: 304/L

*O-RING MATERIAL: FKM

Catalogue PN	Size	A	B	C	D
ISO-CRO-63	ISO63	68.00	70.00	3.90	8
ISO-CRO-80	ISO80	81.00	83.00	3.90	8
ISO-CRO-100	ISO100	100.00	102.00	3.90	8
ISO-CRO-160	ISO160	151.00	153.00	3.90	8
ISO-CRO-200	ISO200	210.00	213.00	3.90	8
ISO-CRO-250	ISO250	256.00	261.00	3.90	8
ISO-CRO-320	ISO320	311.15	316.48	5.50	14

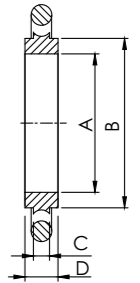

ISO CENTERING RINGS with O-RINGS

*CENTERING RING MATERIAL: 304/L

*O-RING MATERIAL: FKM

Catalogue PN	Size	A	B	C	D
ISO-CRO-63-AL	ISO63	68.00	70.00	3.90	8
ISO-CRO-80-AL	ISO80	81.00	83.00	3.90	8
ISO-CRO-100-AL	ISO100	100.00	102.00	3.90	8
ISO-CRO-160-AL	ISO160	151.00	153.00	3.90	8
ISO-CRO-200-AL	ISO200	210.00	213.00	3.90	8
ISO-CRO-250-AL	ISO250	256.00	261.00	3.90	8
ISO-CRO-320-AL	ISO320	311.15	316.48	5.50	14

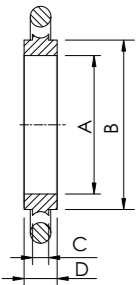

ISO CENTERING RINGS with O-RINGS

*CENTERING RING MATERIAL: 304/L

*O-RING MATERIAL: FKM

Catalogue PN	Size	A	B
ISO-CROS-63	ISO63	94.00	68.00
ISO-CROS-80	ISO80	109.00	81.00
ISO-CROS-100	ISO100	128.00	100.00
ISO-CROS-160	ISO160	179.00	151.00
ISO-CROS-200	ISO200	239.00	210.00
ISO-CROS-250	ISO250	287.00	256.00
ISO-CROS-320	ISO320	346.33	311.15
ISO-CROS-400	ISO400	428.80	392.93

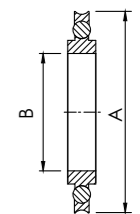

ISO FLANGES & FITTINGS

ISO SCREENED CENTERING RINGS with O-RINGS

*CENTERING RING MATERIAL: 304
*70 MESH SCREEN

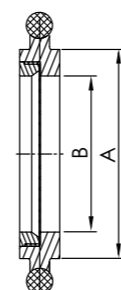

Catalogue PN	Size	A	B
ISO-CROSC-100	ISO100	102.00	92.00
ISO-CROSC-200	ISO160	153.00	139.70
ISO-CROSC-160	ISO200	213.00	206.80

ISO REPLACEMENT O-RINGS

*MATERIAL: FKM

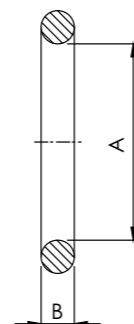

Catalogue PN	Size	A	B
ISO-RO-63	ISO63	72.39	5.33
ISO-RO-80	ISO80	85.09	5.33
ISO-RO-100	ISO100	104.14	5.33
ISO-RO-160	ISO160	151.77	5.33
ISO-RO-200	ISO200	215.27	5.33
ISO-RO-250	ISO250	266.07	5.33
ISO-RO-320	ISO320	316.87	6.99
ISO-RO-400	ISO400	393.07	6.99

NOTE: FFKM O-RING MATERIAL AVAILABLE ON REQUEST.

ISO SPACER RINGS

*MATERIAL: ALUMINUM

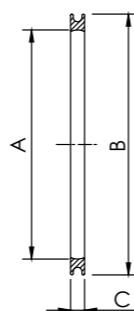

Catalogue PN	Size	A	B	C
ISO-OR-63	ISO63	88.80	98.00	3.75
ISO-OR-80	ISO80	101.80	111.00	3.75
ISO-OR-100	ISO100	120.80	130.00	3.75
ISO-OR-160	ISO160	170.10	179.30	3.75
ISO-OR-200	ISO200	232.10	241.30	3.75
ISO-OR-250	ISO250	282.10	291.30	3.75
ISO-OR-320	ISO320	335.50	344.00	5.59
ISO-OR-400	ISO400	420.30	428.80	5.59

ISO FLANGES & FITTINGS

ISO-K FLANGE PROTECTION CAPS, PLASTIC

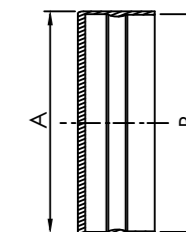

Catalogue PN	Size	A	B
ISOK-PC-63	ISO63	97.8	95.0
ISOK-PC-80	ISO80	113.0	110.0
ISOK-PC-100	ISO100	133.0	130.0
ISOK-PC-160	ISO160	183.0	180.0
ISOK-PC-200	ISO200	242.0	240.0
ISOK-PC-250	ISO250	293.4	290.0
ISOK-PC-320	ISO320	373.9	370.5
ISOK-PC-400	ISO400	454.2	450.8

ISO-K BLANK FLANGES

*MATERIAL: 304/L, 316/L

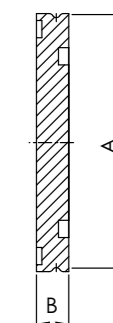

Catalogue PN	Size	A	B	C	D
ISO-CRO-63-AL	ISO63	68.00	70.00	3.90	8
ISO-CRO-80-AL	ISO80	81.00	83.00	3.90	8
ISO-CRO-100-AL	ISO100	100.00	102.00	3.90	8
ISO-CRO-160-AL	ISO160	151.00	153.00	3.90	8
ISO-CRO-200-AL	ISO200	210.00	213.00	3.90	8
ISO-CRO-250-AL	ISO250	256.00	261.00	3.90	8
ISO-CRO-320-AL	ISO320	311.15	316.48	5.50	14

ISO-F BLANK FLANGES

*MATERIAL: 304/L

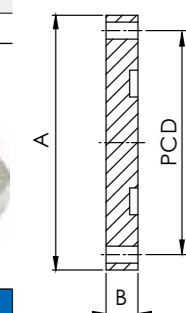

Catalogue PN	Size	A	B
ISO-CROS-63	ISO63	94.00	68.00
ISO-CROS-80	ISO80	109.00	81.00
ISO-CROS-100	ISO100	128.00	100.00
ISO-CROS-160	ISO160	179.00	151.00
ISO-CROS-200	ISO200	239.00	210.00
ISO-CROS-250	ISO250	287.00	256.00
ISO-CROS-320	ISO320	346.33	311.15
ISO-CROS-400	ISO400	428.80	392.93

ISO FLANGES & FITTINGS

ISO-K BORED FLANGES

*MATERIAL: 304

Catalogue PN	Size	A	B	C	D
ISOK-BF-63	ISO63	95.00	60.20	63.80	11.90
ISOK-BF-80	ISO80	110.00	72.90	76.50	11.90
ISOK-BF-100	ISO100	130.00	98.30	101.90	11.90
ISOK-BF-160	ISO160	180.00	149.10	152.90	11.90
ISOK-BF-200	ISO200	240.00	197.10	203.70	11.90
ISOK-BF-250	ISO250	290.00	247.70	254.50	11.90
ISOK-BF-320	ISO320	370.00	296.82	305.56	17.00

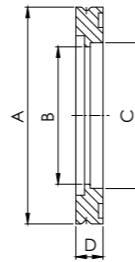

ISO-K BORED FLANGES

*MATERIAL: 304/L

Catalogue PN	Size	A	B	C
ISOK-HN-63	ISO63	95.00	63.50	100.00
ISOK-HN-80	ISO80	110.00	76.20	100.00
ISOK-HN-100	ISO100	130.00	101.60	100.00
ISOK-HN-160	ISO160	180.00	152.40	100.00
ISOK-HN-200	ISO200	240.00	203.20	100.00
ISOK-HN-250	ISO250	290.00	254.00	100.00
ISOK-HN-320	ISO320	370.00	304.80	100.00

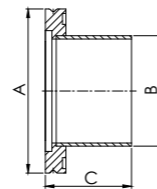

ISO-K BORED FLANGES

*MATERIAL: 304

Catalogue PN	Size	A	B	C	D	PCD
ISOF-BF-63	ISO63	130.00	61.90	63.80	11.90	110.00
ISOF-BF-80	ISO80	145.00	74.60	76.50	11.90	125.00
ISOF-BF-100	ISO100	165.10	99.30	101.92	11.90	145.00
ISOF-BF-160	ISO160	225.00	149.20	152.90	16.00	200.00
ISOF-BF-200	ISO200	285.00	200.00	203.70	16.00	260.00
ISOF-BF-250	ISO250	335.00	250.80	254.50	16.00	310.00
ISOF-BF-320	ISO320	425.00	318.00	324.40	20.00	395.00

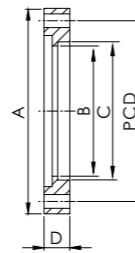

ISO-K BORED FLANGES

*MATERIAL: 304/L

Catalogue PN	Size	A	B	C
ISOF-HN-63	ISO63	130.00	63.50	100.00
ISOF-HN-80	ISO80	145.00	76.20	100.00
ISOF-HN-100	ISO100	165.10	101.60	100.00
ISOF-HN-160	ISO160	225.00	152.40	100.00
ISOF-HN-200	ISO200	285.00	203.20	100.00
ISOF-HN-250	ISO250	335.00	254.00	100.00
ISOF-HN-320	ISO320	425.00	304.80	100.00

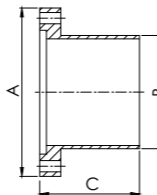

ISO FLANGES & FITTINGS

ISO-K FULL NIPPLES

*MATERIAL: 304

Catalogue PN	Size	A	B	C
ISOK-FN-63	ISO63	ISO63	ISO63	165.10
ISOK-FN-63-1	ISO63	ISO63	ISO63	175.80
ISOK-FN-80	ISO80	ISO80	ISO80	196.10
ISOK-FN-80-1	ISO80	ISO80	ISO80	177.80
ISOK-FN-100	ISO100	ISO100	ISO100	209.80
ISOK-FN-100-1	ISO100	ISO100	ISO100	215.90
ISOK-FN-160	ISO160	ISO160	ISO160	273.30
ISOK-FN-160-1	ISO160	ISO160	ISO160	275.80

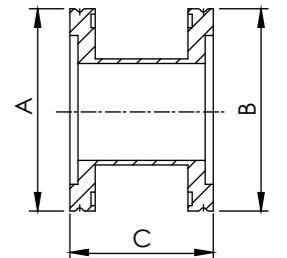

ISO-K REDUCER NIPPLES

*MATERIAL: 304

Catalogue PN	Size	A	B	C
ISOK-SRN-80x63	ISO80x63	ISO80	ISO63	76.20
ISOK-SRN-100x63	ISO100x63	ISO100	ISO63	76.20
ISOK-SRN-100x80	ISO100x80	ISO100	ISO80	76.20
ISOK-SRN-160x63	ISO160x63	ISO160	ISO63	76.20
ISOK-SRN-160x80	ISO160x80	ISO160	ISO80	76.20
ISOK-SRN-160x100	ISO160x100	ISO160	ISO100	76.20

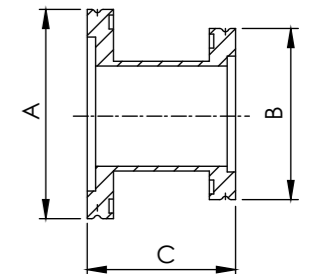

ISO-K CONICAL REDUCERS

*MATERIAL: 304

Catalogue PN	Size	A	B	C
ISOK-CRN-80x63	ISO80x63	ISO80	ISO63	104.70
ISOK-CRN-100x63	ISO100x63	ISO100	ISO63	104.70
ISOK-CRN-100x80	ISO100x80	ISO100	ISO80	104.70

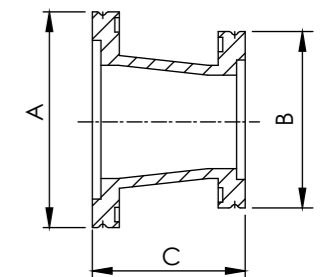

ISO FLANGES & FITTINGS

ISO-K 45° ELBOWS

*MATERIAL: 304

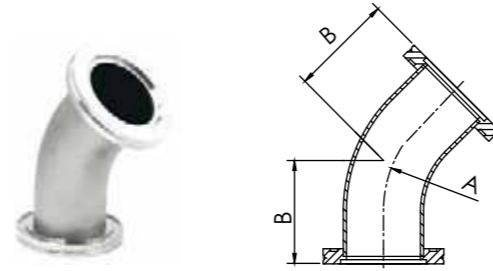

Catalogue PN	Size	A	B
ISOK-45EL-63	ISO63	95.25	82.30
ISOK-45EL-80	ISO80	114.30	100.00
ISOK-45EL-100	ISO100	152.40	128.50

ISO-K 90° ELBOWS

*MATERIAL: 304

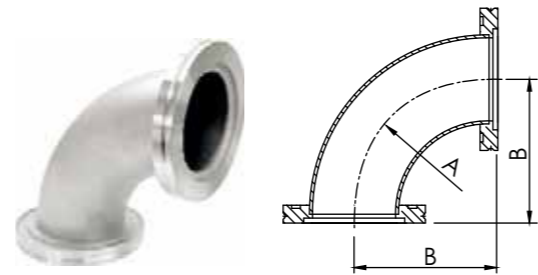

Catalogue PN	Size	A	B
ISOK-90EL-63	ISO63	95.25	101.60
ISOK-90EL-80	ISO80	114.30	120.60
ISOK-90EL-100	ISO100	152.40	158.70

ISO-K 90° MITERED ELBOWS

*MATERIAL: 304

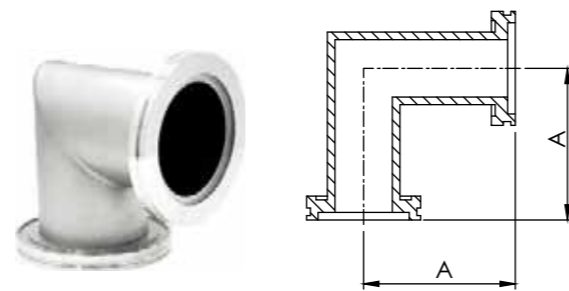

Catalogue PN	Size	A
ISOK-90MEL-63	ISO63	82.60
ISOK-90MEL-63-1	ISO63-H	87.93
ISOK-90MEL-80	ISO80	88.90
ISOK-90MEL-80-1	ISO80-H	108.00
ISOK-90MEL-100	ISO100	104.90
ISOK-90MEL-100-1	ISO100-H	108.00
ISOK-90MEL-160	ISO160	138.00
ISOK-90MEL-160-1	ISO160-H	160.20

ISO FLANGES & FITTINGS

ISO-K EQUAL TEES

*MATERIAL: 304

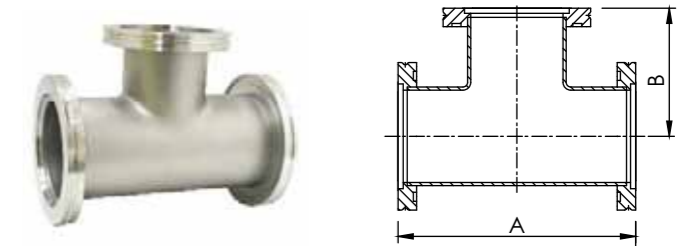

Catalogue PN	Size	A	B
ISOK-ET-63	ISO63	165.00	82.50
ISOK-ET-63-1	ISO63-H	176.00	88.00
ISOK-ET-80	ISO80	177.80	88.90
ISOK-ET-80-1	ISO80-H	196.00	98.00
ISOK-ET-100	ISO100	209.40	104.70
ISOK-ET-100-1	ISO100-H	216.00	108.00
ISOK-ET-160	ISO160	266.60	133.30

ISO-K EQUAL TEES

*MATERIAL: 304

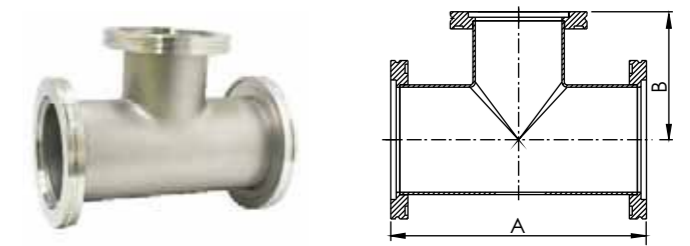

Catalogue PN	Size	A	B
ISOK-RT-80x63	ISO80xISO63	177.70	88.90
ISOK-RT-100x63	ISO100xISO63	209.70	101.60
ISOK-RT-100x80	ISO100xISO80	209.70	101.60
ISOK-RT-160x63	ISO160xISO63	266.60	126.90
ISOK-RT-160x80	ISO160xISO80	266.60	126.90
ISOK-RT-160x100	ISO160xISO100	266.60	130.30

ISO FLANGES & FITTINGS

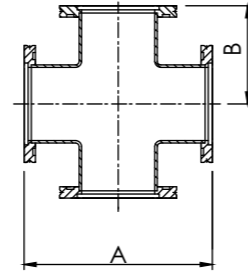

ISO-K 4-WAY CROSSES

*MATERIAL: 304

Catalogue PN	Size	A	B
ISOK-4C-63	ISO63	165.00	82.50
ISOK-4C-80	ISO80	177.80	88.90
ISOK-4C-80-1	ISO80-H	196.00	98.00
ISOK-4C-100	ISO100	209.40	104.70
ISOK-4C-100-1	ISO100-H	216.00	108.00
ISOK-4C-160	ISO160	266.60	133.30

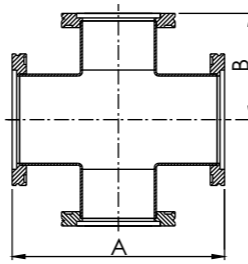

ISO-K 4-WAY REDUCING CROSSES

*MATERIAL: 304

Catalogue PN	Size	A	B
ISOK-4RC-80x63	ISO80xISO63	177.70	88.85
ISOK-4RC-100x63	ISO100xISO63	209.70	101.55
ISOK-4RC-100x80	ISO100xISO80	209.70	101.55
ISOK-4RC-160x63	ISO160xISO63	266.60	126.95
ISOK-4RC-160x80	ISO160xISO80	266.60	126.95
ISOK-4RC-160x100	ISO160xISO100	266.60	130.25



ADAPTORS

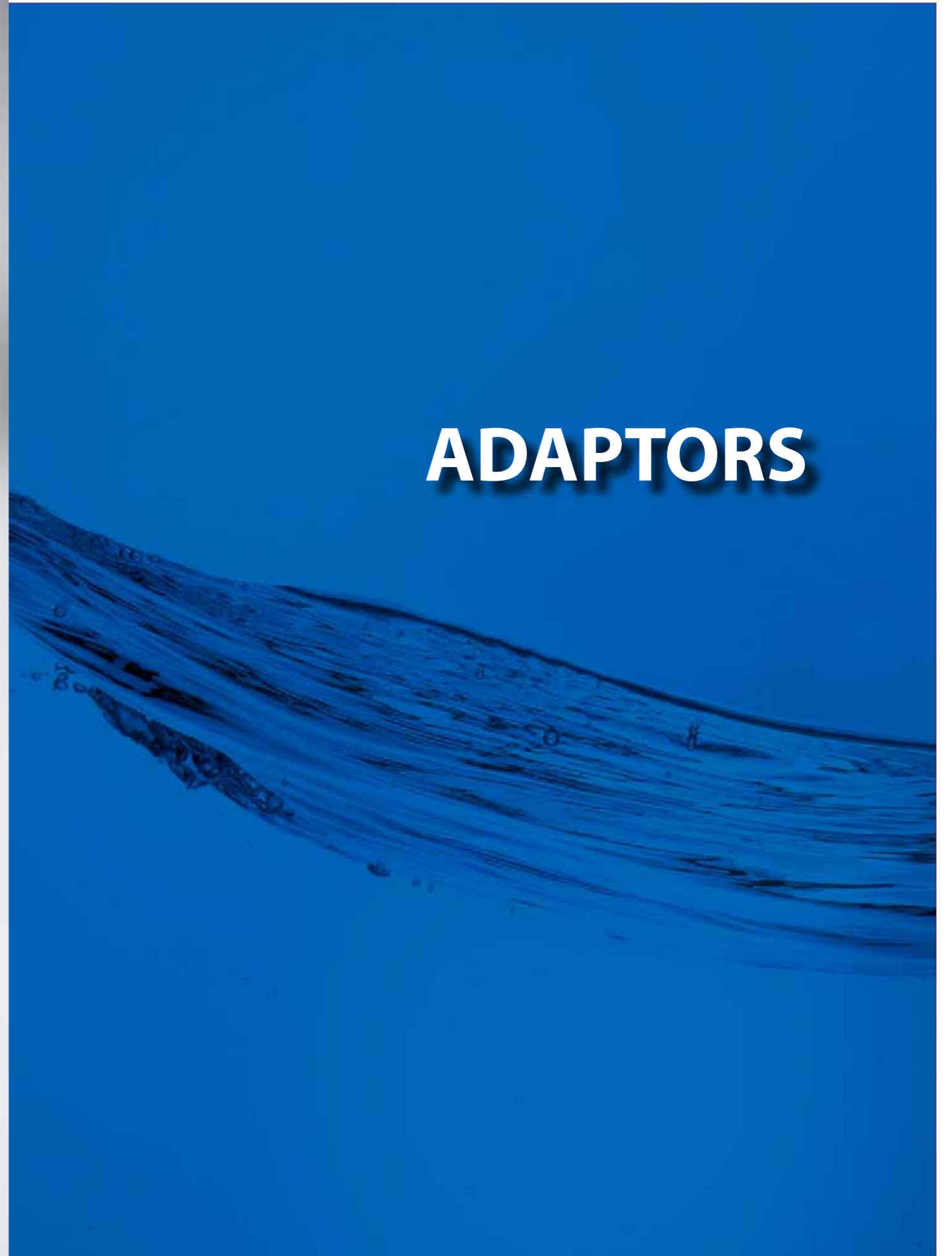

ADAPTORS

KF to CF FLANGE ADAPTORS

*MATERIAL: 304

Catalogue PN	Size	A	B	C
AD-KFCF-10x133	KF10xCF1.33	CF 1.33	KF 10	44.50
AD-KFCF-16x133	KF16xCF1.33	CF 1.33	KF 16	44.50
AD-KFCF-16x275	KF16xCF2.75	CF 2.75	KF 16	45.20
AD-KFCF-25x212	KF25xCF2.12	CF 2.12	KF 25	44.50
AD-KFCF-25x275	KF25xCF2.75	CF 2.75	KF 25	45.20
AD-KFCF-40x275	KF40xCF2.75	CF 2.75	KF 40	45.20
AD-KFCF-40x338	KF40xCF3.38	CF 3.38	KF 40	45.70
AD-KFCF-50x133	KF50xCF1.33	CF 1.33	KF 50	49.50
AD-KFCF-50x275	KF50xCF2.75	CF 2.75	KF 50	49.50
AD-KFCF-50x338	KF50xCF3.38	CF 3.38	KF 50	45.70
AD-KFCF-50x450	KF50xCF4.50	CF 4.50	KF 50	49.50

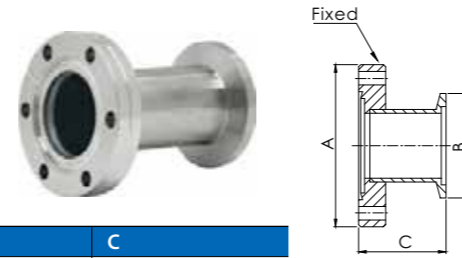

ISO to CF FLANGE ADAPTORS

*MATERIAL: 304

Catalogue PN	Size	A	B	C
AD-ISOCF-63x450	ISO63xCF4.50	CF4.50	ISO63	110.00
AD-ISOCF-80x462	ISO80xCF4.62	CF4.62	ISO80	110.00
AD-ISOCF-80x600	ISO80xCF6.00	CF6.00	ISO80	110.00
AD-ISOCF-100x600	ISO100xCF6.00	CF6.00	ISO100	111.00
AD-ISOCF-160x800	ISO160xCF8.00	CF8.00	ISO160	113.00
AD-ISOCF-200x1000	ISO200xCF10.00	CF10.00	ISO200	113.00

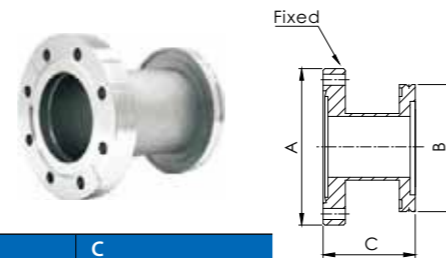

ISO to KF FLANGE ADAPTORS

*MATERIAL: 304

Catalogue PN	Size	A	B	C
AD-ISOKF-63x25	ISO63-KF25	ISO63	KF 25	46.50
AD-ISOKF-63x40	ISO63-KF40	ISO63	KF 40	46.30
AD-ISOKF-63x50	ISO63-KF50	ISO63	KF 50	46.30
AD-ISOKF-80x40	ISO80-KF40	ISO80	KF 40	46.30
AD-ISOKF-80x50	ISO80-KF50	ISO80	KF 50	46.30
AD-ISOKF-100x40	ISO100-KF40	ISO100	KF 40	46.30
AD-ISOKF-100x50	ISO100-KF50	ISO100	KF 50	46.30

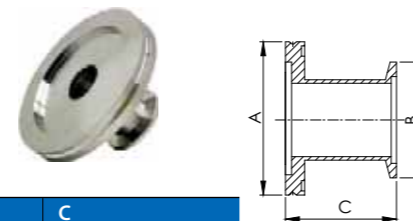

ADAPTORS

ISO to CF FLANGE CONICAL ADAPTORS

*MATERIAL: 304

Catalogue PN	Size	A	B	C
AD-C-ISOCF-63x275	ISO63-CF2.75	ISO63	CF2.75	71.90
AD-C-ISOCF-63x338	ISO63-CF3.38	ISO63	CF3.38	72.30
AD-C-ISOCF-63x462	ISO63-CF4.62	ISO63	CF 4.62	105.50
AD-C-ISOCF-63x600	ISO63-CF6.00	ISO63	CF 6.00	109.50
AD-C-ISOCF-80x275	ISO80-CF2.75	ISO80	CF 2.75	103.70
AD-C-ISOCF-80x338	ISO80-CF3.38	ISO80	CF 3.38	104.10
AD-C-ISOCF-80x450	ISO80-CF4.50	ISO80	CF 4.50	107.90
AD-C-ISOCF-80x600	ISO80-CF6.00	ISO80	CF 6.00	109.50
AD-C-ISOCF-100x338	ISO100-CF3.38	ISO100	CF 3.38	104.10
AD-C-ISOCF-100x450	ISO100-CF4.50	ISO100	CF 4.50	107.90
AD-C-ISOCF-100x462	ISO100-CF4.62	ISO100	CF 4.62	105.50

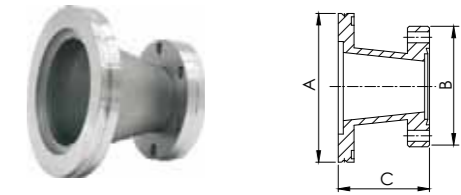

KF to CF FLANGE CONICAL ADAPTORS

*MATERIAL: 304

Catalogue PN	Size	A	B	C
AD-C-KFCF-16x212	KF16-CF2.12	KF 16	CF 2.12	42.90
AD-C-KFCF-16x275	KF16-CF2.75	KF 16	CF 2.75	69.30
AD-C-KFCF-25x133	KF25-CF1.33	KF 25	CF 1.33	43.15
AD-C-KFCF-25x275	KF25-CF2.75	KF 25	CF 2.75	69.30
AD-C-KFCF-25x338	KF25-CF3.38	KF25	CF 3.38	69.90
AD-C-KFCF-40x133	KF40-CF1.33	KF 40	CF 1.33	68.55
AD-C-KFCF-40x212	KF40-CF2.12	KF 40	CF 2.12	68.30
AD-C-KFCF-40x338	KF40-CF3.38	KF 40	CF 3.38	69.90
AD-C-KFCF-40x450	KF40-CF4.50	KF 40	CF 4.50	73.70
AD-C-KFCF-40x462	KF40-CF4.62	KF 40	CF 4.62	103.10
AD-C-KFCF-50x212	KF50-CF2.12	KF 50	CF 2.12	68.30
AD-C-KFCF-50x275	KF50-CF2.75	KF 50	CF 2.75	69.30
AD-C-KFCF-50x450	KF50-CF4.50	KF 50	CF 4.50	73.70
AD-C-KFCF-50x462	KF50-CF4.62	KF 50	CF 4.62	103.10
AD-C-KFCF-50x600	KF50-CF6.00	KF 50	CF 6.00	106.90

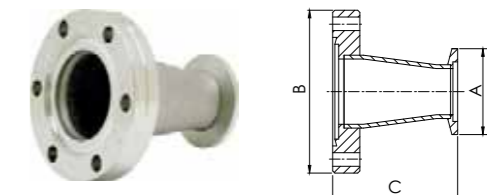

ADAPTORS

ISO to KF FLANGE CONICAL ADAPTORS

*MATERIAL: 304

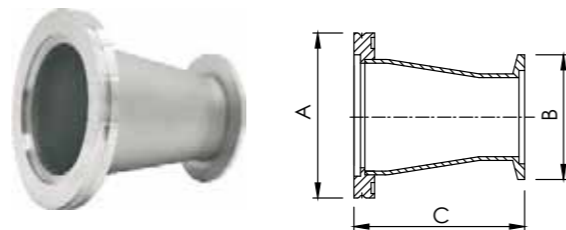

Catalogue PN	Size	A	B	C
AD-C-ISOKF-63x40	ISO63-KF40	ISO63	KF 40	70.40
AD-C-ISOKF-63x50	ISO63-KF50	ISO63	KF 50	70.40
AD-C-ISOKF-80x40	ISO80-KF40	ISO80	KF 40	102.20
AD-C-ISOKF-80x50	ISO80-KF50	ISO80	KF 50	102.20
AD-C-ISOKF-100x50	ISO100-KF50	ISO100	KF 50	102.20

KF FLANGES to QUICK COUPLINGS with VITON O-RINGS

*MATERIAL: 304

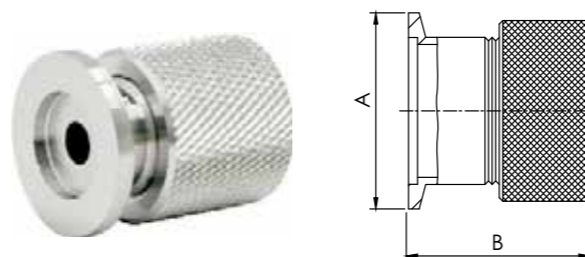

Catalogue PN	Size	Tube Size	A	B
AD-QC-KF10x050	NW10-1/2"	1/2"	30.00	38.10
AD-QC-KF16x025	NW16-1/4"	1/4"	30.00	35.60
AD-QC-KF16x050	NW16-1/2"	1/2"	30.00	38.10
AD-QC-KF16x075	NW16-3/4"	3/4"	30.00	45.70
AD-QC-KF25x050	NW25-1/2"	1/2"	40.00	38.10
AD-QC-KF25x062	NW25-5/8"	5/8"	40.00	43.20
AD-QC-KF25x075	NW25-3/4"	3/4"	40.00	45.70
AD-QC-KF25x100	NW25-1.0"	1.0"	40.00	50.80
AD-QC-KF25x112	NW25-1 1/8"	1-1/8"	40.00	50.80
AD-QC-KF40x050	NW40-1/2"	1/2"	55.00	37.60
AD-QC-KF40x075	NW40-3/4"	3/4"	55.00	45.70
AD-QC-KF40x100	NW40-1.0"	1.0"	55.00	50.80
AD-QC-KF40x112	NW40-1 1/8"	1-1/8"	55.00	50.80
AD-QC-KF40x125	NW40-1 1/4"	1-1/4"	55.00	50.80
AD-QC-KF40x138	NW40-1 3/8"	1-3/8"	55.00	53.30
AD-QC-KF40x150	NW40-1 1/2"	1-1/2"	55.00	61.00
AD-QC-KF50x050	NW50-1/2"	1/2"	75.00	38.10
AD-QC-KF50x075	NW50-3/4"	3/4"	75.00	45.70
AD-QC-KF50x100	NW50-1.0"	1.0"	75.00	50.80
AD-QC-KF50x112	NW50-1 1/8"	1-1/8"	75.00	50.80
AD-QC-KF50x150	NW50-1 1/2"	1-1/2"	75.00	61.00
AD-QC-KF50x200	NW50-2.0"	2.0"	75.00	61.00